



Thread mill with end-cutting edge for high hardness steels

AT-2

Volume 2



New type for tapered
pipe threads (Rc & NPT)
 $\frac{1}{16}$ ~1 - 6 items each



KEY FEATURES: AT-2

Helical drilling + threading can be done simultaneously !



AT-2: THREAD MILL WITH END-CUTTING EDGE FOR HIGH HARDNESS STEELS

No pilot hole is required!
Stable machining without chip trouble

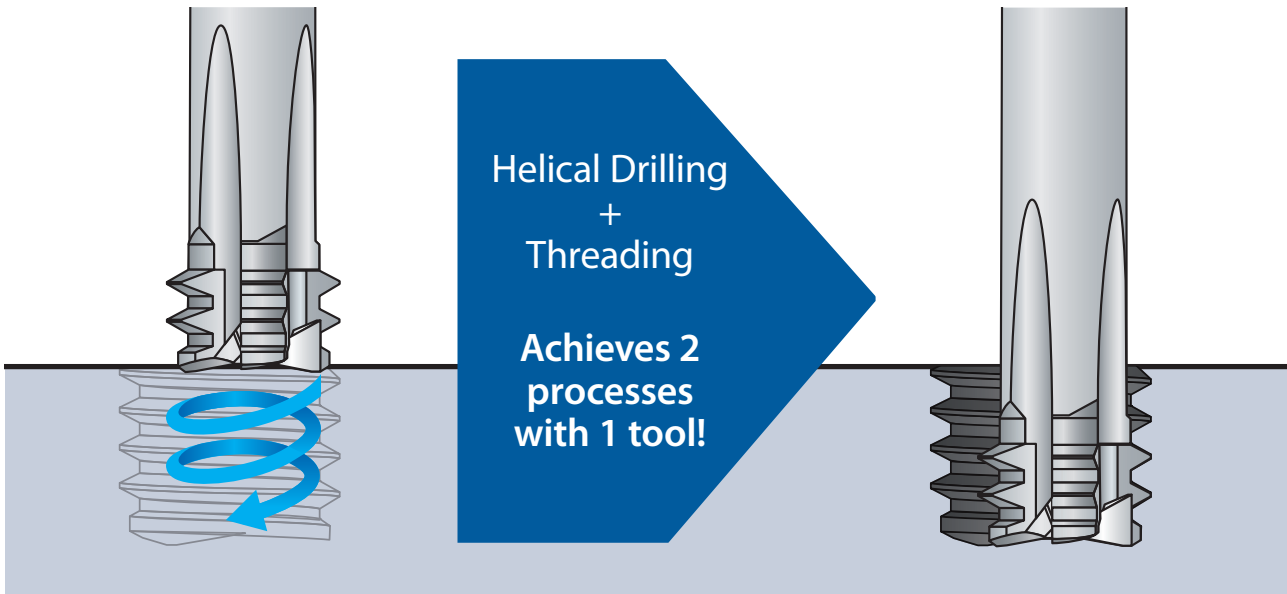

Threading | Thread milling

3 Supportive Tools for Your Thread Milling Needs

- 1 ThreadPro**
Creates programs easily
Thread Milling NC Code Generator Software

Web ThreadPro

AT-2 is supported by Web version only
Web version of ThreadPro is now available

- 2 RPRG**
Reduces correction works
Reference value of tool radius offset

- 3 DCT**
Stabilizes tool life
Diameter Correction Tool

AT-2 2D Type

Threading | Thread milling | Metric & Metric Fine

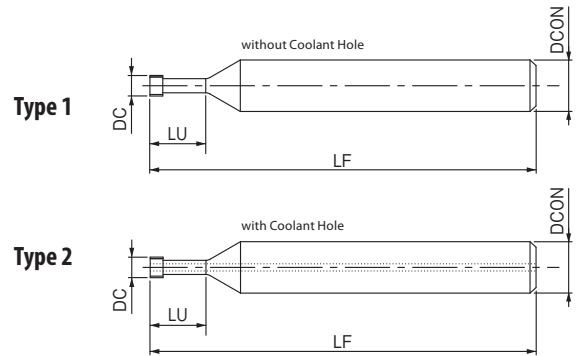

- First choice in quality and performance
- Thread mill with end-cutting edge for high hardness steels
- DUROREY coating

P ○ C < 0,2%	P ○ 0,25 < C < 0,4	P ○ C > 0,45%	P ○ SCM	M ○ INOX	K ○ GG	K ○ GGG	N ○ Al	N ○ AC,ADC	S ● Ti	S ● Ni	H ● 25-45 HRC	H ● 45-50 HRC	H ● 50-65 HRC	
35-55	80-160	80-160	60-120	35-100	35-100	35-100	35-100	35-100	35-55	35-55	35-75	35-65	35-55	m/min
0,01~0,07	0,01~0,07	0,01~0,07	0,01~0,07	0,01~0,07	0,01~0,07	0,01~0,07	0,01~0,07	0,01~0,07	0,01~0,07	0,01~0,07	0,01~0,07	0,01~0,07	0,01~0,07	mm/t

Threading | Thread milling



EDP	cutting bore ∅	Max. cutting bore ∅	TP	DC	LF	Maximum threading length	LU	DCON	ZEFP	Type	Price
8331200	M3	4,2	0,5	2,4	50	6	7,25	6	4	1	
8331201	M4	5,3	0,7	3,1	50	8	9,75	6	4	1	
8331202	M5	7	0,8	4	50	10	12	6	4	1	
8331203	M6	8	1	4,6	50	12	14,5	6	4	1	
8331204	M8	10,9	1,25	6,2	70	16	19,12	10	4	1	
8331205	M10	13,2	1,5	7,5	70	20	23,75	10	4	2	
8331206	M12	15,9	1,75	9	80	24	28,37	10	4	2	
special item	M16	21,1	2	11,7	100	32	37	12	4	2	
special item	M18	25,1	2,5	14	135	36	42,25	16	4	2	
special item	M20	28,5	2,5	15,7	135	40	46,25	16	4	2	

Metric & Metric fine

AT-2 2,5D Type

Threading | Thread milling | Metric & Metric Fine



EDP	cutting bore ∅	Max. cutting bore ∅	TP	DC	LF	Maximum threading length	LU	DCON	ZEFP	Type	Price
8331207	M3	4,2	0,5	2,4	50	7,5	8,75	6	4	1	
8331208	M4	5,3	0,7	3,1	50	10	11,75	6	4	1	
8331209	M5	7	0,8	4	50	12,5	14,5	6	4	1	
8331210	M6	8	1	4,6	50	15	17,5	6	4	1	
8331211	M8	10,9	1,25	6,2	70	20	23,12	10	4	1	
8331212	M10	13,2	1,5	7,5	70	25	28,75	10	4	2	
8331213	M12	15,9	1,75	9	80	30	34,37	10	4	2	
special item	M16	21,1	2	11,7	100	40	45	12	4	2	
special item	M18	25,1	2,5	14	135	45	51,25	16	4	2	
special item	M20	28,5	2,5	15,7	135	50	56,25	16	4	2	

AT-2 2D Type

Threading | Thread milling | U, UNJ, UNC, UNJC, UNF, UNJF

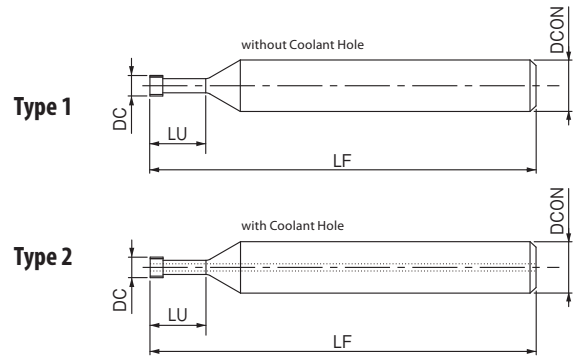

- First choice in quality and performance
- Thread mill with end-cutting edge for high hardness steels
- DUREOREY coating

P ○ C < 0,2%	P ○ 0,25 < C < 0,4	P ○ C > 0,45%	P ○ SCM	M ○ INOX	K ○ GG	K ○ GGG	N ○ Al	N ○ AC,ADC	S ● Ti	S ● Ni	H ● 25-45 HRC	H ● 45-50 HRC	H ● 50-65 HRC	
35-55	80-160	80-160	60-120	35-100	35-100	35-100	35-100	35-100	35-55	35-55	35-75	35-65	35-55	m/min
0,01~0,07	0,01~0,07	0,01~0,07	0,01~0,07	0,01~0,07	0,01~0,07	0,01~0,07	0,01~0,07	0,01~0,07	0,01~0,07	0,01~0,07	0,01~0,07	0,01~0,07	0,01~0,07	mm/t



EDP	cutting bore ∅	Max. cutting bore ∅	TPI	DC	LF	Maximum threading length	LU	DCON	ZEFP	Type	Price
special item	N°8	4,7	32	3,1	50	8,33	10,31	6	4	1	
special item	N°10	6,1	24	3,7	70	9,65	12,29	6	4	1	
special item	1/4	7,6	20	4,55	70	12,7	15,87	6	4	1	
special item	1/4	8	28	4,55	70	12,7	14,96	6	4	1	
special item	5/16	9,7	18	5,7	80	15,88	19,4	10	4	1	
special item	3/8	11,6	16	6,7	80	19,05	23,01	10	4	1	
special item	7/16	13,3	14	7,7	80	22,22	26,75	10	4	2	
special item	1/2	16,2	13	9,2	80	25,4	30,28	10	4	2	

AT-2 2,5D Type

Threading | Thread milling | U, UNJ, UNC, UNJC, UNF, UNJF



EDP	cutting bore ∅	Max. cutting bore ∅	TPI	DC	LF	Maximum threading length	LU	DCON	ZEFP	Type	Price
special item	N°8	4,7	32	3,1	50	10,42	12,4	6	4	1	
special item	N°10	6,1	24	3,7	70	12,07	14,71	6	4	1	
special item	1/4	7,6	20	4,55	70	15,88	19,05	6	4	1	
special item	1/4	8	28	4,55	70	15,88	18,14	6	4	1	
special item	5/16	9,7	18	5,7	80	19,85	23,37	10	4	1	
special item	3/8	11,6	16	6,7	80	23,81	27,77	10	4	1	
special item	7/16	13,3	14	7,7	80	27,78	32,31	10	4	2	
special item	1/2	16,2	13	9,2	80	31,75	36,63	10	4	2	

AT-2

Threading | Thread milling | RC (PT)

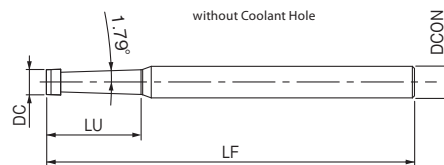

- First choice in quality and performance
- Thread mill with end-cutting edge for high hardness steels
- DUOREY coating

P ○ C < 0.2%	P ○ 0.25 < C < 0.4	P ○ C > 0.45%	P ○ SCM	M ○ INOX	K ○ GG	K ○ GGG	N ○ Al	N ○ AC,ADC	S ● Ti	S ● Ni	H ● 25-45 HRC	H ● 45-50 HRC	H ● 50-65 HRC	
35-55	80-160	80-160	60-120	35-100	35-100	35-100	35-100	35-100	35-55	35-55	35-75	35-65	35-55	m/min
0,01~0,07	0,01~0,07	0,01~0,07	0,01~0,07	0,01~0,07	0,01~0,07	0,01~0,07	0,01~0,07	0,01~0,07	0,01~0,07	0,01~0,07	0,01~0,07	0,01~0,07	0,01~0,07	mm/t

Threading | Thread milling

A **Rc (PT)** **CARBIDE** **DUOREY** **h6**

EDP	cutting bore ∅	Max. cutting bore ∅	TPI	DC	LF	Maximum threading length	LU	DCON	ZEFP	Price
8331214	1/16	1/8	28	4,86	70	15,8	18	6	4	
8331215	1/8	-	28	5,76	70	16,8	19	6	4	
8331216	1/4	3/8	19	7,98	80	24,76	28	10	4	
8331217	3/8	-	19	9,68	80	24,76	28	10	4	
8331218	1/2	3/4	14	11,61	110	30,6	35	12	4	
special item	1	1	11	15,54	135	39,4	45	16	4	

RC (PT), NPT

AT-2

Threading | Thread milling | NPT



A **NPT** **CARBIDE** **DUOREY** **h6**

EDP	cutting bore ∅	Max. cutting bore ∅	TPI	DC	LF	Maximum threading length	LU	DCON	ZEFP	Price
special item	1/16	1/8	27	4,86	70	15,7	18	6	4	
special item	1/8	-	27	5,76	70	16,7	19	6	4	
special item	1/4	3/8	18	7,98	80	24,5	28	10	4	
special item	3/8	-	18	9,68	80	24,5	28	10	4	
special item	1/2	3/4	14	11,61	110	30,5	35	12	4	
special item	1	1	11,5	15,54	135	39,6	45	16	4	

CUTTING DATA

The standard outer diameter (DC) of the tapered pipe type represents the dimension of the outer diameter of the central cutting edge.

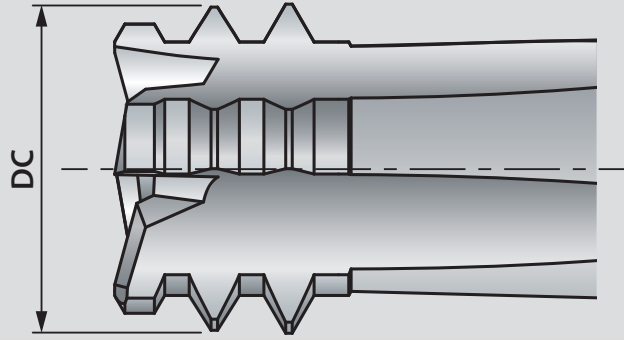

Thread mills are ideal for machining tapered pipe threads

High-precision threading can be achieved with no stop marks and high roundness

Stop Marks



Processing by tap



Processing by thread mill

Capable of processing even shallower tapered threads than tapered pipe taps

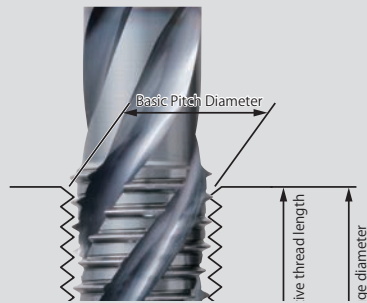

Processing by tap

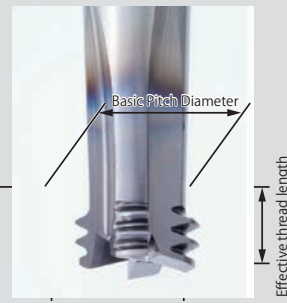

Processing by thread mill

Even if the drill hole is shallow and the tap cannot be inserted to the gauge diameter position, a thread mill can process tapered threads that are shallower than the short thread standard by specifying the thread length through programming.

AT-2: IDEAL FOR HIGHLY DIFFICULT HIGH HARDNESS STEEL APPLICATIONS!

Helical drilling + threading can be done simultaneously, which reduces the risk of potential machining problems in the processing of high hardness steels

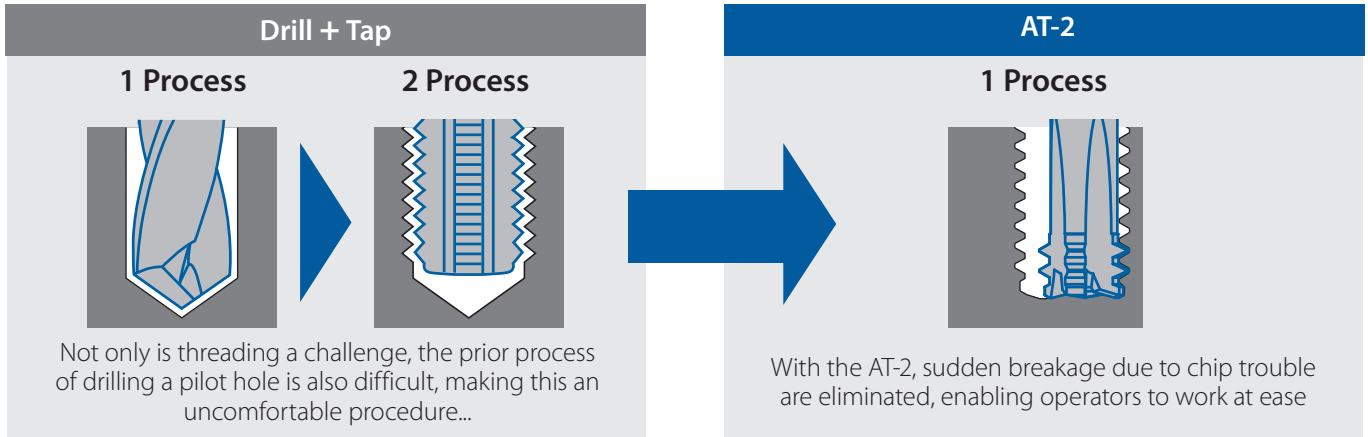

The risk of sudden tool breakage can be minimized by breaking chips into small and manageable pieces and evacuating them smoothly. Since no pilot hole is required, process integration and the risk of breakage can be avoided.

Long and stable tool life with higher thread quality compared to cutting taps

Tool	AT-2 Ø6,2 × 16 P1,25	Carbide hand tap for high hardness steels M8×1,25 3P
Work Material	SKD11 (60HRC)	
Cutting Speed	45m/min (2.310min ⁻¹)	2m/min (80min ⁻¹)
Feed	83mm/min(0,04m-m/t)	100mm/min
Drill Hole Size	None	Ø6,8 × 23,5mm (Blind)
Internal Thread size	M8×1,25	
Threading Length	16mm (2D)	
Coolant	Air Blow	Non-Water-Soluble
Machine	Horizontal Machining Center	Vertical Machining Center

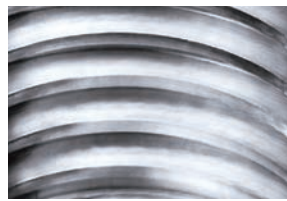
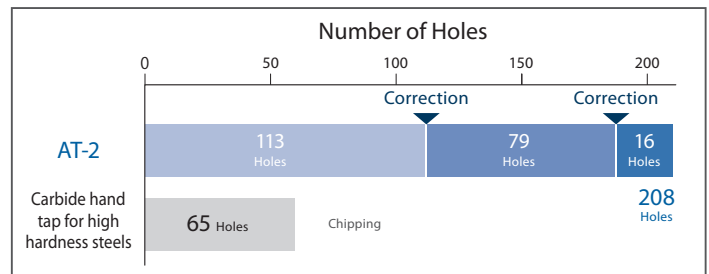

Coating Structure

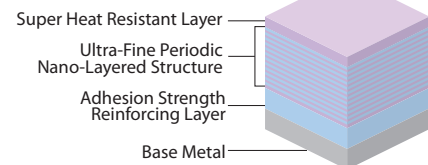

DUROREY

Newly developed DUROREY coating enables superior heat resistance and high toughness optimized for high-hardness steel milling!

Super heat resistant layer and ultra-fine periodic nano-layered structure provide superior toughness while maintaining high heat resistance and abrasion resistance. Also suppresses chipping even in high hardness milling and achieves long tool life.

Coating Color	Coating Structure	(GPa) Hardness	(C°) Oxidation Temperature	Heat Resistance	Adhesion Strength	Surface Roughness	Wear Resistance	Welding Resistance	Toughness
Black Gray	Ultra-Fine Periodic Nano-Layered	41	1.300	☆	◎	○	☆	◎	◎

○ → ◎ → ☆
Fair Best

Evaluation method of cutting test

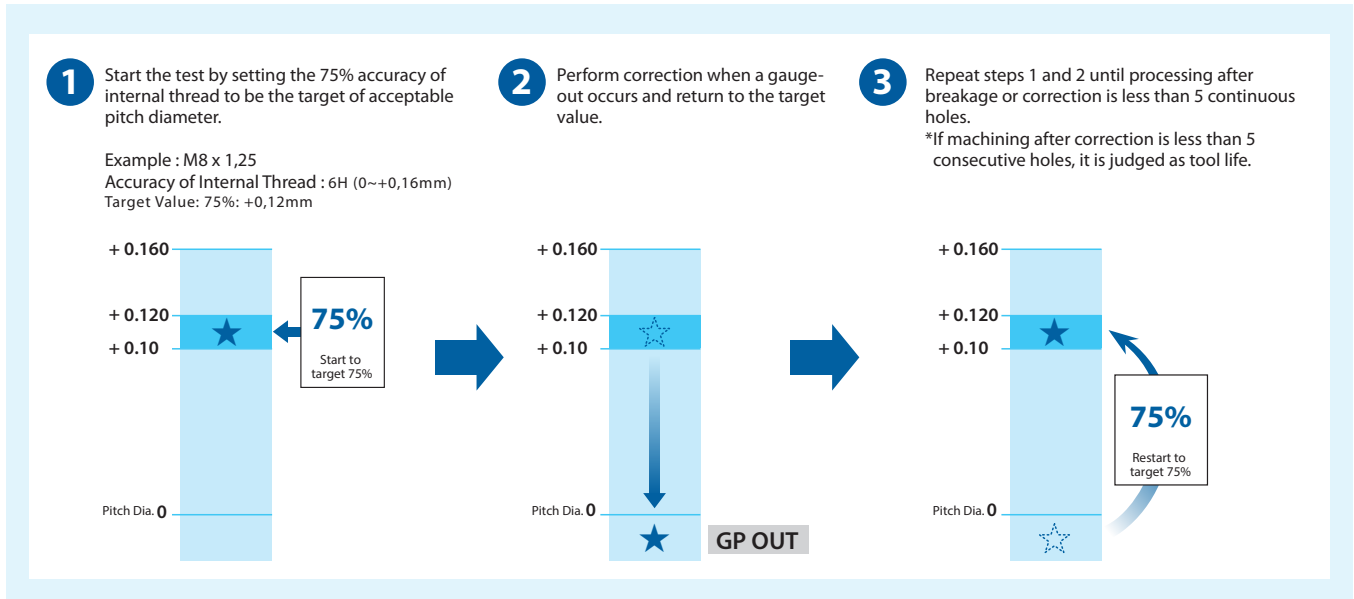

Outstanding durability by cutting with air-blow

Size	Ø3,1 × 8 P0,7	Ø6,2 × 16 P1,25	Ø7,5 × 20 P1,5
Work Material	SKD11 (60 HRC)		
Cutting Speed	45 m/min (4.621min ⁻¹)	45 m/min (2.310min ⁻¹)	35 m/min (1.485min ⁻¹)
Feed	46 mm/min (0,011mm/t)	83 mm/min (0,04mm/t)	56 mm/min (0,038mm/t)
Internal Thread Size	M4 x 0,7	M8 x 1,25	M10 x 1,25
Threading Length	7 mm	14,8 mm	18,5 mm
Coolant	Air Blow		
Machine	(BT40) Horizontal Machining Center	(HSK63) Vertical Machining Center	

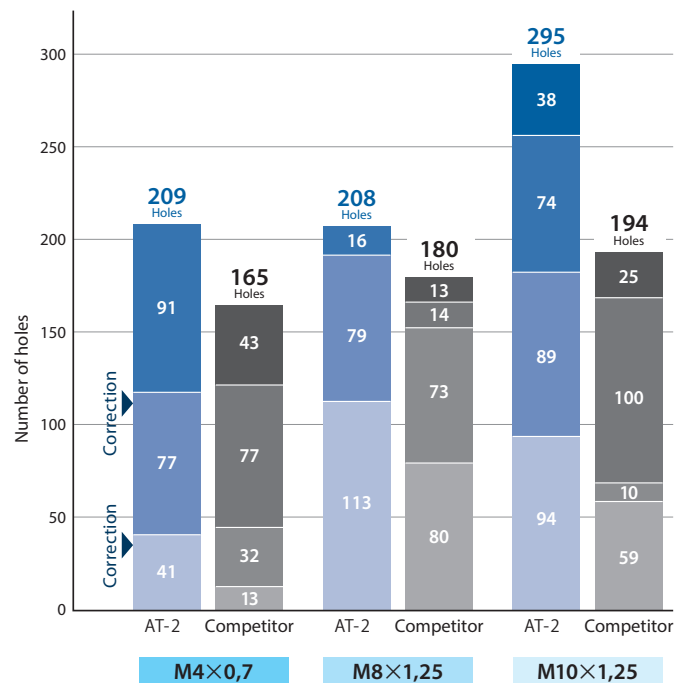

Stable durability with water-soluble coolant

Size	Ø4 x 10 P0,8	Ø7,5 x 20 P1,5
Work Material	SKD11 (60 HRC)	
Cutting Speed	45 m/min (3.581min ⁻¹)	45 m/min (1.910min ⁻¹)
Feed	66 mm/min (0,023mm/t)	73 mm/min (0,038mm/t)
Internal Thread Size	M5 x 0,8	M10 x 1,25
Threading Length	9,2 mm	18,5 mm
Coolant	Water-Soluble	
Machine	(BT40) Horizontal Machining Center	(HSK63) Vertical Machining Center

Unlike processing with cutting taps, which often involves the use of non-water-soluble coolant, water-soluble coolant can be used with the AT-2, reducing the need to replace machines.

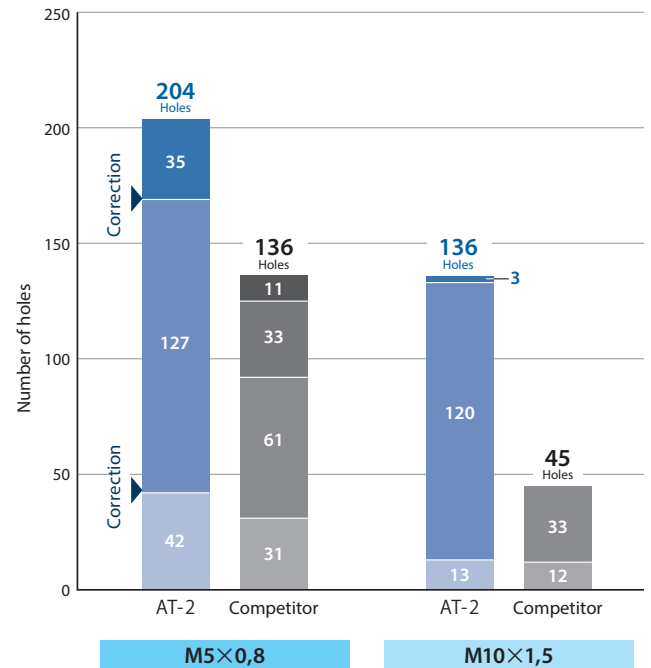

Stable threading of 2,5 x D made possible

Tool	AT-2 Ø7,5x25 P1,5
Work Material	SKD11 (60 HRC)
Cutting Speed	35 m/min (1.485min ⁻¹)
Feed	56 mm/min (0,038mm/t)
Internal Thread Size	M10 x 1,5
Threading Length	22,5 mm
Coolant	Air Blow
Machine	(HSK63) Vertical Machining Center

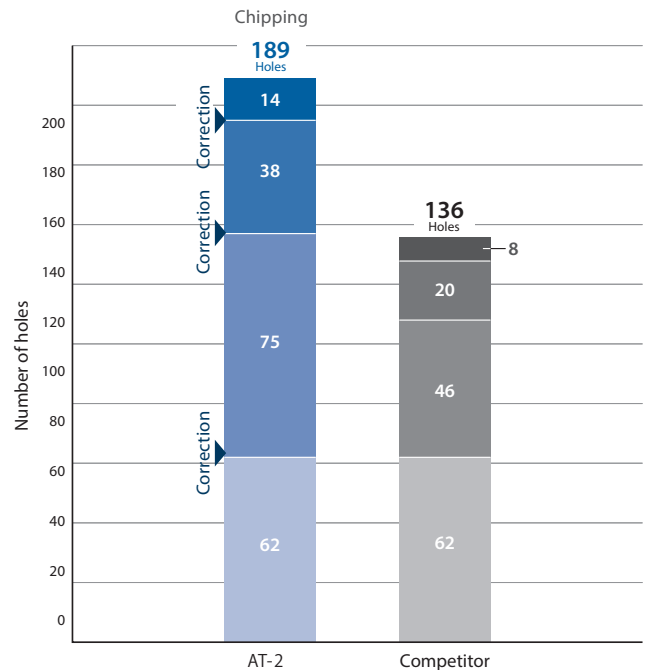

CUTTING DATA

Remarkable durability in 65 HRC work material

Tool	AT-2 Ø4 × 10 P0,8
Work Material	(60 HRC) Equivalent to SKH
Cutting Speed	45 m/min (3.581 min ⁻¹)
Feed	29 mm/min (0,01mm/t)
Internal Thread Size	M5 x 0,8
Threading Length	8 mm (2D)
Coolant	Air Blow
Machine	Horizontal Machining Center

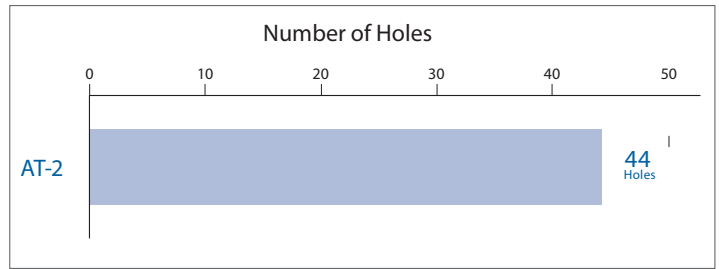

Stable processing is made possible even in tapered pipe threads of 60 HRC

Tool	AT-2 Ø5,76 × 16,8 Rc28
Work Material	SKD11 (60HRC)
Cutting Speed	45 m/min (2.512 min ⁻¹)
Feed	39 mm/min (0,01mm/t)
Internal Thread Size	Rc 1/8-28
Threading Length	6,2 mm
Coolant	Air Blow
Machine	Vertical Machining Center (BT40)

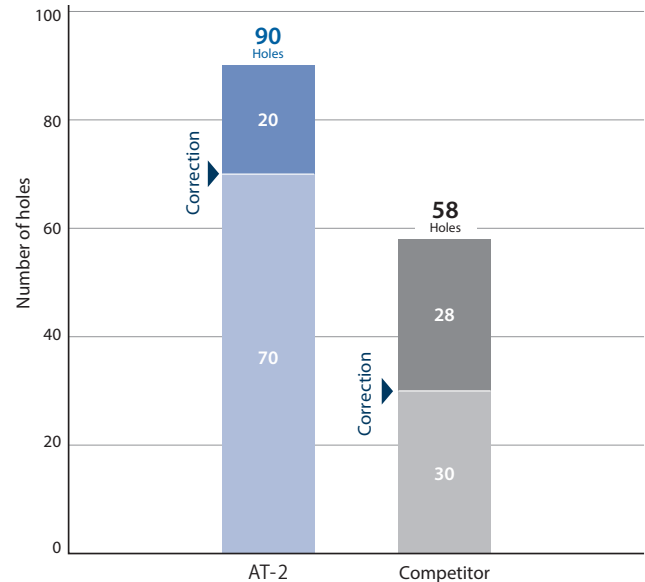

Processing of tapered pipe threads in general steel

Tool	AT-2 Ø5,76 × 16,8 Rc28		
Work Material	STAVAX (50HRC)	NAK80 (40HRC)	S45C
Cutting Speed	45 m/min (2.512 min ⁻¹)		
Feed	39 mm/min (0,01mm/t)		
Internal Thread Size	Rc 1/8-28		
Threading Length	6,2 mm		
Coolant	Air Blow		
Machine	Vertical Machining Center (BT40)		

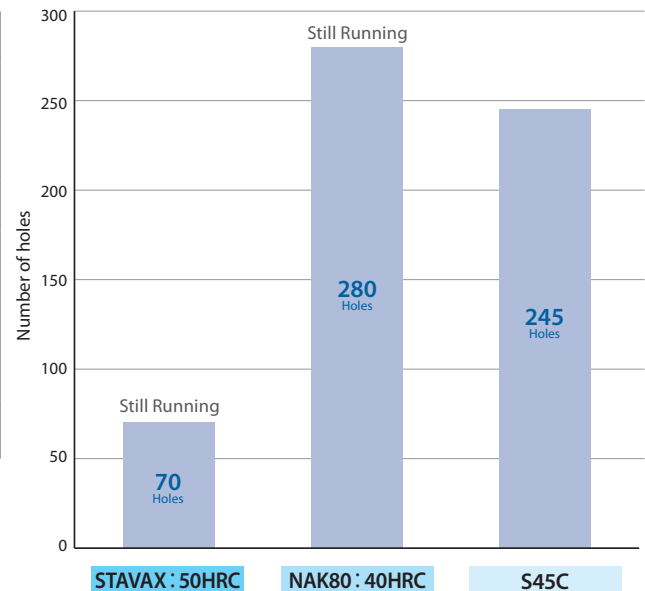

CUTTING DATA

Excellent durability even in STAVAX (around 50 HRC)

Tool	AT-2 Ø7,5x20 P1,5	
Work Material	STAVAX (53 HRC)	SKD (50 HRC)
Cutting Speed	55 m/min (2.331min ⁻¹)	
Feed	89 mm/min (0,038mm/t)	
Internal Thread Size	M10 X 1,5	
Threading Length	18 mm	
Coolant	Air Blow	
Machine	(BT40) Horizontal Machining Center	

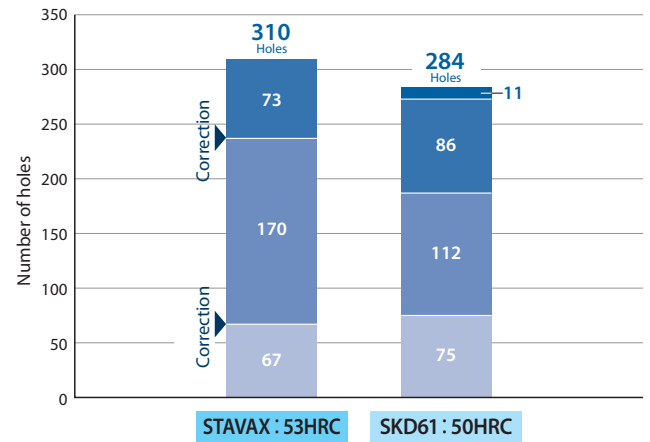

Threading | Thread milling

Stable performance even in general steels

Tool	AT-2 Ø3,1x8 P0,7	
Work Material	SS400	S50C
Cutting Speed	45 m/min (4.621min ⁻¹)	85 m/min (8.728min ⁻¹)
Feed	46 mm/min (0,011mm/t)	86 mm/min (0,011mm/t)
Internal Thread Size	M4 X 0,7	
Threading Length	7 mm (2D)	
Coolant	Water-Soluble	
Machine	Vertical Machining Center	

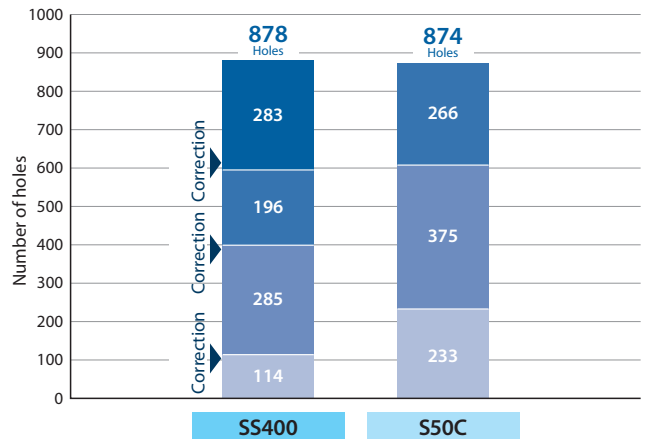

Since there is no cutting chip trouble, it is effective for avoiding the risk of tool breakage. Processing consolidation is also made possible.





Please refer to the following table to select a suitable coolant for cutting.

Work Material	AT-2	
	Air Blow	Water-Soluble
High-hardness steel	⊙	△
General steel	×	⊙

⊙ : Best
 △ : Shortening of tool life
 × : Not recommended

Water-soluble cutting fluids can be used with satisfactory result, although in some cases the durability is inferior to air-blow.

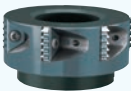
Tool selection based on work material and application.

High Hardness Steel	Steel-Stainless Steel	Nonferrous Metal	Heat-Resistant Alloy
	<p>A The A Brand</p> <p>AT-1 One pass thread mill</p>  <ul style="list-style-type: none"> Thread milling in 1-pass Compatible thread classification : M, U, Rc, Rp, NPT 		
	<p>A The A Brand</p> <p>AT-2 With end-cutting edge</p>  <ul style="list-style-type: none"> Helical drilling + threading can be done simultaneously Compatible with a wide range of work materials including high hardness steels* Compatible thread classification: M, U 		
		<p>WX-PNC For Nonferrous Metal and Heat-Resistant Alloy</p>  <ul style="list-style-type: none"> Ideal for processing non-ferrous metals and heat-resistant alloys Compatible thread classification : M, U, Rc, Rp, NPT 	
		<p>HY PRO P Indexable Type</p>  <ul style="list-style-type: none"> Compatible for processing large diameter threads Compatible thread classification : M, U, G, W, Rc, NPT, NPTF 	
	<p>WH-VM-PNC For Small Diameter</p>  <ul style="list-style-type: none"> Compatible for small diameter threads from M1 to M5 Compatible thread classification : S, M, U 		

Thread M Metric thread U Unified thread Rc, NPT, NPTF Taper pipe thread Rp, G Parallel pipe thread W Whitworth thread S Miniature thread

* For heat-resistant alloys (titanium alloys and Ni-based alloys), refer to the cutting condition standard table and use an oil hole compatible size (oil hole column with ○ mark) with water-soluble cutting oil.

For details of other thread mill offering





CUTTING CONDITIONS

Threading | Thread milling | Cutting conditions

AT-2



			Low Carbon Steel - Mild Steel ~C0,25%			Medium Carbon Steel - High Carbon Steel ~C0,25%			Alloy Steel SCM		
Recommended Coolant			Water-Soluble			Water-Soluble			Water-Soluble		
Vc (m/min)			35 ~ 55			80 ~ 160			60 ~ 120		
Thread	Thread Size	DC	Speed (min ⁻¹)	Feed (mm/min)	Feed per Tooth (mm/t)	Speed (min ⁻¹)	Feed (mm/min)	Feed per Tooth (mm/t)	Speed (min ⁻¹)	Feed (mm/min)	Feed per Tooth (mm/t)
M	M 3 x0,5	2,4	5.968	48	0,01	10.610	85	0,01	7.958	64	0,01
	M 4 x0,7	3,1	4.621	62	0,015	8.214	111	0,015	6.161	83	0,015
	M 5 x0,8	4	3.581	49	0,017	6.366	87	0,017	4.775	65	0,017
	M 6 x1	4,6	3.114	58	0,02	5.536	103	0,02	4.152	78	0,02
	M 8 x1,25	6,2	2.310	62	0,03	4.107	111	0,03	3.080	83	0,03
	M 10 x1,5	7,5	1.910	67	0,035	3.395	119	0,035	2.546	89	0,035
	M 12 x1,75	9	1.592	72	0,045	2.829	127	0,045	2.122	95	0,045
	M 16 x2	11,7	1.224	72	0,055	2.176	129	0,055	1.632	96	0,055
	M 18 x2,5	14	1.023	55	0,06	1.819	97	0,06	1.364	73	0,06
	M 20 x2,5	15,7	912	51	0,065	1.622	91	0,065	1.216	68	0,065
U	No. 8 - 32UNC	3,1	4.621	47	0,01	8.214	84	0,01	6.161	63	0,01
	No. 10 - 24UNC	3,7	3.871	54	0,015	6.882	96	0,015	5.162	72	0,015
	1/4 - 20UNC	4,55	3.148	89	0,025	5.597	159	0,025	4.197	119	0,025
	1/4 - 28UNF	4,55	3.148	89	0,025	5.597	159	0,025	4.197	119	0,025
	5/16 - 18UNC	5,7	2.513	85	0,03	4.468	151	0,03	3.351	113	0,03
	3/8 - 16UNC	6,7	2.138	89	0,035	3.801	158	0,035	2.851	118	0,035
	7/16 - 14UNC	7,7	1.860	91	0,04	3.307	162	0,04	2.480	122	0,04
	1/2 - 13UNC	9,2	1.557	77	0,045	2.768	137	0,045	2.076	103	0,045
	1/16 - 28	4,86	2.982	*1	0,025	5.302	*1	0,025	3.976	*1	0,025
	1/8 - 28	5,76	2.512	*1	0,03	4.465	*1	0,03	3.349	*1	0,03
Rc (PT)	1/4 - 19	7,98	1.814	*1	0,04	3.225	*1	0,04	2.419	*1	0,04
	3/8 - 19	9,68	1.493	*1	0,045	2.654	*1	0,045	1.990	*1	0,045
	1/2 - 14	11,61	1.246	*1	0,055	2.215	*1	0,055	1.661	*1	0,055
	1 - 11	15,54	930	*1	0,065	1.654	*1	0,065	1.240	*1	0,065
	1/16 - 27	4,86	2.984	*1	0,025	5.304	*1	0,025	3.978	*1	0,025
NPT	1/8 - 27	5,76	2.513	*1	0,03	4.467	*1	0,03	3.350	*1	0,03
	1/4 - 18	7,98	1.815	*1	0,04	3.227	*1	0,04	2.420	*1	0,04
	3/8 - 18	9,68	1.493	*1	0,045	2.655	*1	0,045	1.991	*1	0,045
	1/2 - 14	11,61	1.246	*1	0,055	2.215	*1	0,055	1.661	*1	0,055
	1 - 11 1/2	15,54	930	*1	0,065	1.653	*1	0,065	1.240	*1	0,065

Threading | Thread milling



			Hardened Steel								
			25~45 HRC			45~50 HRC			50~65 HRC		
Recommended Coolant			Air-Blow								
Vc (m/min)			35 ~ 75			35 ~ 65			35 ~ 55		
Thread	Thread Size	DC	Speed (min ⁻¹)	Feed (mm/min)	Feed per Tooth (mm/t)	Speed (min ⁻¹)	Feed (mm/min)	Feed per Tooth (mm/t)	Speed (min ⁻¹)	Feed (mm/min)	Feed per Tooth (mm/t)
M	M 3 x0,5	2,4	5.968	48	0,01	5.968	48	0,01	5.968	48	0,01
	M 4 x0,7	3,1	4.621	62	0,015	4.621	62	0,015	4.621	62	0,015
	M 5 x0,8	4	3.581	49	0,017	3.581	49	0,017	3.581	49	0,017
	M 6 x1	4,6	3.114	58	0,02	3.114	58	0,02	3.114	58	0,02
	M 8 x1,25	6,2	2.310	62	0,03	2.310	62	0,03	2.310	62	0,03
	M 10 x1,5	7,5	1.910	67	0,035	1.910	67	0,035	1.910	67	0,035
	M 12 x1,75	9	1.592	72	0,045	1.592	72	0,045	1.592	72	0,045
	M 16 x2	11,7	1.224	72	0,055	1.224	72	0,055	1.224	72	0,055
	M 18 x2,5	14	1.023	55	0,06	1.023	55	0,06	1.023	55	0,06
	M 20 x2,5	15,7	912	51	0,065	912	51	0,065	912	51	0,065
U	No. 8 - 32UNC	3,1	4.621	47	0,01	4.621	47	0,01	4.621	47	0,01
	No. 10 - 24UNC	3,7	3.871	54	0,015	3.871	54	0,015	3.871	54	0,015
	1/4 - 20UNC	4,55	3.148	89	0,025	3.148	89	0,025	3.148	89	0,025
	1/4 - 28UNF	4,55	3.148	89	0,025	3.148	89	0,025	3.148	89	0,025
	5/16 - 18UNC	5,7	2.513	85	0,03	2.513	85	0,03	2.513	85	0,03
	3/8 - 16UNC	6,7	2.138	89	0,035	2.138	89	0,035	2.138	89	0,035
	7/16 - 14UNC	7,7	1.860	91	0,04	1.860	91	0,04	1.860	91	0,04
	1/2 - 13UNC	9,2	1.557	77	0,045	1.557	77	0,045	1.557	77	0,045
	1/16 - 28	4,86	2.982	*1	0,025	2.982	*1	0,025	2.982	*1	0,025
	1/8 - 28	5,76	2.512	*1	0,03	2.512	*1	0,03	2.512	*1	0,03
Rc (PT)	1/4 - 19	7,98	1.814	*1	0,04	1.814	*1	0,04	1.814	*1	0,04
	3/8 - 19	9,68	1.493	*1	0,045	1.493	*1	0,045	1.493	*1	0,045
	1/2 - 14	11,61	1.246	*1	0,055	1.246	*1	0,055	1.246	*1	0,055
	1 - 11	15,54	930	*1	0,065	930	*1	0,065	930	*1	0,065
	1/16 - 27	4,86	2.984	*1	0,025	2.984	*1	0,025	2.984	*1	0,025
NPT	1/8 - 27	5,76	2.513	*1	0,03	2.513	*1	0,03	2.513	*1	0,03
	1/4 - 18	7,98	1.815	*1	0,04	1.815	*1	0,04	1.815	*1	0,04
	3/8 - 18	9,68	1.493	*1	0,045	1.493	*1	0,045	1.493	*1	0,045
	1/2 - 14	11,61	1.246	*1	0,055	1.246	*1	0,055	1.246	*1	0,055
	1 - 11 1/2	15,54	930	*1	0,065	930	*1	0,065	930	*1	0,065

* Values vary depending on the depth of hole to be machined.

- 1, This cutting condition table shows standard values, When machining, it is recommended to use the program created by the NC code generator software ThreadPro,
- 2, Please adjust the cutting conditions depending on the rigidity of machine, tool holders, and workpiece clamping,
- 3, Tool vibrations should be kept at a minimum level for maximum accuracy,
- 4, When machining magnesium alloy materials, please use the coolant oil recommended by the coolant oil manufacturer, Please also properly dispose the cutting chips to prevent fire hazards,
- 5, Spindle rotation must be counterclockwise due to the left-hand cut configuration,

CUTTING CONDITIONS

Threading | Thread milling | Cutting conditions

AT-2

			Stainless Steel - Tool Steel SUS304 - SKD			Cast Steel - Cast Iron - Ductile Cast Iron SC - FC - FCD			Copper - Brass - Brass Casting - Bronze Cu - Bs - BsC - PB					
			~20HRC						20HRC~					
Recommended Coolant			Water-Soluble			Air-Blow			Water-Soluble					
Vc (m/min)			35 ~ 100			35 ~ 100			35 ~ 100			35 ~ 75		
Thread	Thread Size	DC	Speed (min ⁻¹)	Feed (mm/min)	Feed per Tooth (mm/t)	Speed (min ⁻¹)	Feed (mm/min)	Feed per Tooth (mm/t)	Speed (min ⁻¹)	Feed (mm/min)	Feed per Tooth (mm/t)	Speed (min ⁻¹)	Feed (mm/min)	Feed per Tooth (mm/t)
M	M 3 ×0,5	2,4	5.968	48	0,01	7.958	64	0,01	7.958	64	0,01	5.968	48	0,01
	M 4 ×0,7	3,1	4.621	62	0,015	6.161	83	0,015	6.161	83	0,015	4.621	62	0,015
	M 5 ×0,8	4	3.581	49	0,017	4.775	65	0,017	4.775	65	0,017	3.581	49	0,017
	M 6 ×1	4,6	3.114	58	0,02	4.152	78	0,02	4.152	78	0,02	3.114	58	0,02
	M 8 ×1,25	6,2	2.310	62	0,03	3.080	83	0,03	3.080	83	0,03	2.310	62	0,03
	M 10 ×1,5	7,5	1.910	67	0,035	2.546	89	0,035	2.546	89	0,035	1.910	67	0,035
	M 12 ×1,75	9	1.592	72	0,045	2.122	95	0,045	2.122	95	0,045	1.592	72	0,045
	M 16 ×2	11,7	1.224	72	0,055	1.632	96	0,055	1.632	96	0,055	1.224	72	0,055
	M 18 ×2,5	14	1.023	55	0,06	1.364	73	0,06	1.364	73	0,06	1.023	55	0,06
M 20 ×2,5	15,7	912	51	0,065	1.216	68	0,065	1.216	68	0,065	912	51	0,065	
U	No. 8 - 32UNC	3,1	4.621	47	0,01	6.161	63	0,01	6.161	63	0,01	4.621	47	0,01
	No. 10 - 24UNC	3,7	3.871	54	0,015	5.162	72	0,015	5.162	72	0,015	3.871	54	0,015
	1/4 - 20UNC	4,55	3.148	89	0,025	4.197	119	0,025	4.197	119	0,025	3.148	89	0,025
	1/4 - 28UNF	4,55	3.148	89	0,025	4.197	119	0,025	4.197	119	0,025	3.148	89	0,025
	5/16 - 18UNC	5,7	2.513	85	0,03	3.351	113	0,03	3.351	113	0,03	2.513	85	0,03
	3/8 - 16UNC	6,7	2.138	89	0,035	2.851	118	0,035	2.851	118	0,035	2.138	89	0,035
	7/16 - 14UNC	7,7	1.860	91	0,04	2.480	122	0,04	2.480	122	0,04	1.860	91	0,04
	1/2 - 13UNC	9,2	1.557	77	0,045	2.076	103	0,045	2.076	103	0,045	1.557	77	0,045
	1/16 - 28	4,86	2.982	*1	0,025	3.976	*1	0,025	3.976	*1	0,025	2.982	*1	0,025
Rc (PT)	1/8 - 28	5,76	2.512	*1	0,03	3.349	*1	0,03	3.349	*1	0,03	2.512	*1	0,03
	1/4 - 19	7,98	1.814	*1	0,04	2.419	*1	0,04	2.419	*1	0,04	1.814	*1	0,04
	3/8 - 19	9,68	1.493	*1	0,045	1.990	*1	0,045	1.990	*1	0,045	1.493	*1	0,045
	1/2 - 14	11,61	1.246	*1	0,055	1.661	*1	0,055	1.661	*1	0,055	1.246	*1	0,055
	1 - 11	15,54	930	*1	0,065	1.240	*1	0,065	1.240	*1	0,065	930	*1	0,065
	1/16 - 27	4,86	2.984	*1	0,025	3.978	*1	0,025	3.978	*1	0,025	2.984	*1	0,025
	1/8 - 27	5,76	2.513	*1	0,03	3.350	*1	0,03	3.350	*1	0,03	2.513	*1	0,03
	1/4 - 18	7,98	1.815	*1	0,04	2.420	*1	0,04	2.420	*1	0,04	1.815	*1	0,04
	3/8 - 18	9,68	1.493	*1	0,045	1.991	*1	0,045	1.991	*1	0,045	1.493	*1	0,045
NPT	1/2 - 14	11,61	1.246	*1	0,055	1.661	*1	0,055	1.661	*1	0,055	1.246	*1	0,055
	1 - 11 1/2	15,54	930	*1	0,065	1.240	*1	0,065	1.240	*1	0,065	930	*1	0,065

Threading | Thread milling

			Aluminum Rolled Steel - Aluminum Alloy Casting AL - AC _ ADC			Magnesium Alloy Casting - Zinc Alloy Casting MC - ZDC			Titanium Alloy Ti-6Al-4V		
			Water-Soluble						Water-Soluble		
Recommended Coolant			Water-Soluble			Water-Soluble			Water-Soluble		
Vc (m/min)			35 ~ 100			35 ~ 100			35 ~ 55		
Thread	Thread Size	DC	Speed (min ⁻¹)	Feed (mm/min)	Feed per Tooth (mm/t)	Speed (min ⁻¹)	Feed (mm/min)	Feed per Tooth (mm/t)	Speed (min ⁻¹)	Feed (mm/min)	Feed per Tooth (mm/t)
M	M 3 ×0,5	2,4	10.610	85	0,01	7.958	64	0,01	5.968	48	0,01
	M 4 ×0,7	3,1	8.214	111	0,015	6.161	83	0,015	4.621	62	0,015
	M 5 ×0,8	4	6.366	87	0,017	4.775	65	0,017	3.581	49	0,017
	M 6 ×1	4,6	5.536	103	0,02	4.152	78	0,02	3.114	58	0,02
	M 8 ×1,25	6,2	4.107	111	0,03	3.080	83	0,03	2.310	62	0,03
	M 10 ×1,5	7,5	3.395	119	0,035	2.546	89	0,035	1.910	67	0,035
	M 12 ×1,75	9	2.829	127	0,045	2.122	95	0,045	1.592	72	0,045
	M 16 ×2	11,7	2.176	129	0,055	1.632	96	0,055	1.224	72	0,055
	M 18 ×2,5	14	1.819	97	0,06	1.364	73	0,06	1.023	55	0,06
M 20 ×2,5	15,7	1.622	91	0,065	1.216	68	0,065	912	51	0,065	
U	No. 8 - 32UNC	3,1	8.214	84	0,01	6.161	63	0,01	4.621	47	0,01
	No. 10 - 24UNC	3,7	6.882	96	0,015	5.162	72	0,015	3.871	54	0,015
	1/4 - 20UNC	4,55	5.597	159	0,025	4.197	119	0,025	3.148	89	0,025
	1/4 - 28UNF	4,55	5.597	159	0,025	4.197	119	0,025	3.148	89	0,025
	5/16 - 18UNC	5,7	4.468	151	0,03	3.351	113	0,03	2.513	85	0,03
	3/8 - 16UNC	6,7	3.801	158	0,035	2.851	118	0,035	2.138	89	0,035
	7/16 - 14UNC	7,7	3.307	162	0,04	2.480	122	0,04	1.860	91	0,04
	1/2 - 13UNC	9,2	2.768	137	0,045	2.076	103	0,045	1.557	77	0,045
	1/16 - 28	4,86	5.302	*1	0,025	3.976	*1	0,025	2.982	*1	0,025
Rc (PT)	1/8 - 28	5,76	4.465	*1	0,03	3.349	*1	0,03	2.512	*1	0,03
	1/4 - 19	7,98	3.225	*1	0,04	2.419	*1	0,04	1.814	*1	0,04
	3/8 - 19	9,68	2.654	*1	0,045	1.990	*1	0,045	1.493	*1	0,045
	1/2 - 14	11,61	2.215	*1	0,055	1.661	*1	0,055	1.246	*1	0,055
	1 - 11	15,54	1.654	*1	0,065	1.240	*1	0,065	930	*1	0,065
	1/16 - 27	4,86	5.304	*1	0,025	3.978	*1	0,025	2.984	*1	0,025
	1/8 - 27	5,76	4.467	*1	0,03	3.350	*1	0,03	2.513	*1	0,03
	1/4 - 18	7,98	3.227	*1	0,04	2.420	*1	0,04	1.815	*1	0,04
	3/8 - 18	9,68	2.655	*1	0,045	1.991	*1	0,045	1.493	*1	0,045
NPT	1/2 - 14	11,61	2.215	*1	0,055	1.661	*1	0,055	1.246	*1	0,055
	1 - 11 1/2	15,54	1.653	*1	0,065	1.240	*1	0,065	930	*1	0,065

*1. Values vary depending on the depth of hole to be machined.

1. This cutting condition table shows standard values. When machining, it is recommended to use the program created by the NC code generator software ThreadPro.
2. Please adjust the cutting conditions depending on the rigidity of machine, tool holders, and workpiece clamping.
3. Tool vibrations should be kept at a minimum level for maximum accuracy.
4. When machining magnesium alloy materials, please use the coolant oil recommended by the coolant oil manufacturer. Please also properly dispose the cutting chips to prevent fire hazards.
5. Spindle rotation must be counterclockwise due to the left-hand cut configuration.

* For titanium alloys and Ni-based alloys, the above condition table applies only when using a water-soluble cutting fluid and processing with a thread length approximately 1xD or an oil hole compatible size (oil hole column: ◯ mark).

CUTTING CONDITIONS

Threading | Thread milling | Cutting conditions

AT-2



			Ni-based Alloy - Inconel			Plastic		
Recommended Coolant			Water-Soluble			Water-Soluble		
Vc (m/min)			35 ~ 55			35 ~ 100		
Thread	Thread Size	DC	Speed (min ⁻¹)	Feed (mm/min)	Feed per Tooth (mm/t)	Speed (min ⁻¹)	Feed (mm/min)	Feed per Tooth (mm/t)
M	M 3 x0,5	2,4	4.642	37	0,01	7.958	64	0,01
	M 4 x0,7	3,1	3.594	49	0,015	6.161	83	0,015
	M 5 x0,8	4	2.785	38	0,017	4.775	65	0,017
	M 6 x1	4,6	2.422	45	0,02	4.152	78	0,02
	M 8 x1,25	6,2	1.797	49	0,03	3.080	83	0,03
	M 10 x1,5	7,5	1.485	52	0,035	2.546	89	0,035
	M 12 x1,75	9	1.238	56	0,045	2.122	95	0,045
	M 16 x2	11,7	952	56	0,055	1.632	96	0,055
	M 18 x2,5	14	796	42	0,06	1.364	73	0,06
	M 20 x2,5	15,7	710	40	0,065	1.216	68	0,065
U	No, 8 - 32UNC	3,1	3.594	37	0,01	6.161	63	0,01
	No, 10 - 24UNC	3,7	3.011	42	0,015	5.162	72	0,015
	1/4 - 20UNC	4,55	2.449	69	0,025	4.197	119	0,025
	1/4 - 28UNF	4,55	2.449	69	0,025	4.197	119	0,025
	5/16 - 18UNC	5,7	1.955	66	0,03	3.351	113	0,03
	3/8 - 16UNC	6,7	1.663	69	0,035	2.851	118	0,035
	7/16 - 14UNC	7,7	1.447	71	0,04	2.480	122	0,04
	1/2 - 13UNC	9,2	1.211	60	0,045	2.076	103	0,045
	1/16 - 28	4,86	2.320	*1	0,025	3.976	*1	0,025
	1/8 - 28	5,76	1.954	*1	0,03	3.349	*1	0,03
RC (PT)	1/4 - 19	7,98	1.411	*1	0,04	2.419	*1	0,04
	3/8 - 19	9,68	1.161	*1	0,045	1.990	*1	0,045
	1/2 - 14	11,61	969	*1	0,055	1.661	*1	0,055
	1 - 11	15,54	724	*1	0,065	1.240	*1	0,065
NPT	1/16 - 27	4,86	2.321	*1	0,025	3.978	*1	0,025
	1/8 - 27	5,76	1.954	*1	0,03	3.350	*1	0,03
	1/4 - 18	7,98	1.412	*1	0,04	2.420	*1	0,04
	3/8 - 18	9,68	1.161	*1	0,045	1.991	*1	0,045
	1/2 - 14	11,61	969	*1	0,055	1.661	*1	0,055
	1 - 11 1/2	15,54	723	*1	0,065	1.240	*1	0,065

*1. Values vary depending on the depth of hole to be machined.

- This cutting condition table shows standard values. When machining, it is recommended to use the program created by the NC code generator software ThreadPro.
- Please adjust the cutting conditions depending on the rigidity of machine, tool holders, and workpiece clamping.
- Tool vibrations should be kept at a minimum level for maximum accuracy.
- When machining magnesium alloy materials, please use the coolant oil recommended by the coolant oil manufacturer. Please also properly dispose the cutting chips to prevent fire hazards.
- Spindle rotation must be counterclockwise due to the left-hand cut configuration.

* For titanium alloys and Ni-based alloys, the above condition table applies only when using a water-soluble cutting fluid and processing with a thread length approximately 1xD or an oil hole compatible size (oil hole column: ○ mark).

Formula for calculating the feed rate of thread mill

$$V_f = \frac{f z \times z \times n \times (D_m - D_c)}{D_m} \text{ (mm/min)}$$

v_f	Feed (mm/min)	z	Number of Flutes
D_m	Actual Dia. (mm)	f	Feed (mm/t)
D_c	Tool Dia. (mm)	n	Speed (min ⁻¹)
Note Internal: -		External: +	

For the arc cutting process of machining external and internal threads, the feed rate at the tool center can be obtained by multiplying the linear cut feed rate with a coefficient. The formulas for calculating coefficients vary between external and internal thread cutting. The formula listed left are for calculating the tool feed rate during arc-cutting, including calculating the coefficients to be used for multiplication with the linear-cut feed rate.

PROPER USAGE OF COOLANT

When using external coolant, ensure that the cutting fluid is properly positioned so that it is supplied into the hole.

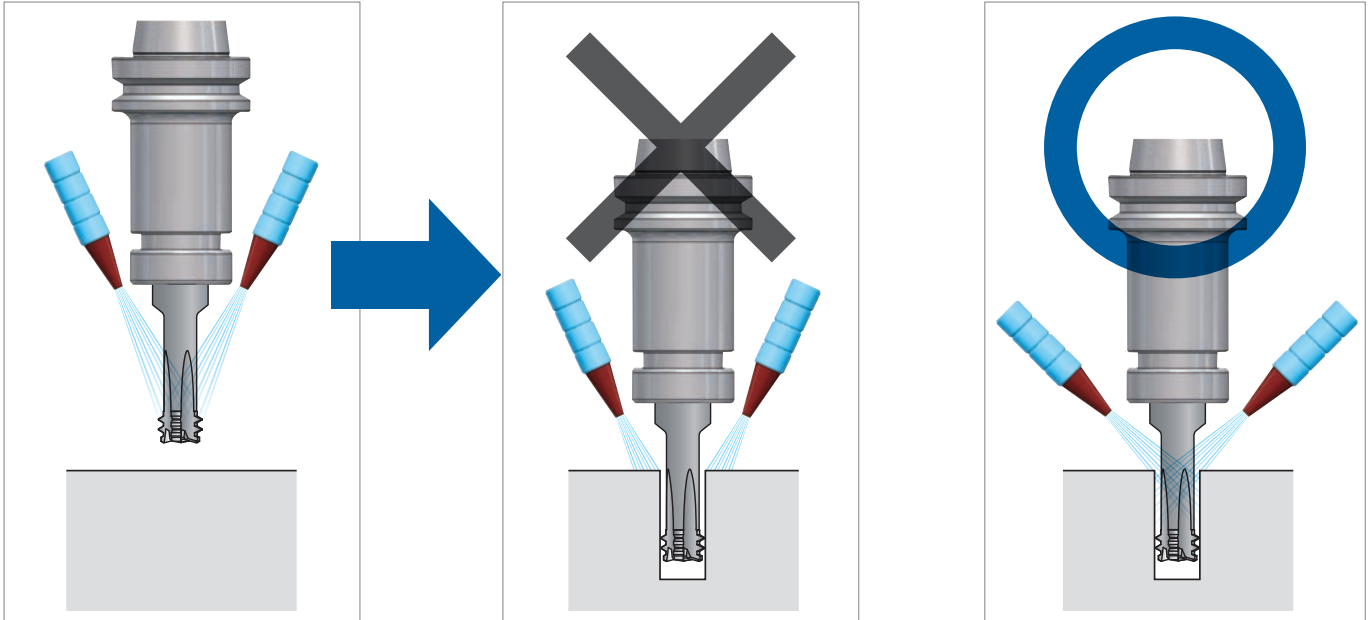

If you are using a machining center with a through-spindle coolant system, the use of coolant through collet is recommended.

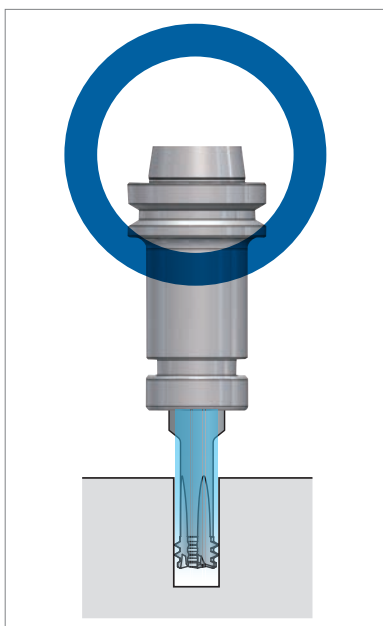

Please refer to the following table to select a suitable coolant for cutting.

Work Material	AT-2	
	Air Blow	Water-Soluble
High-hardness steel	◎	△
General steel	×	◎

◎ : Best
 △ : Shortening of tool life
 × : Not recommended

Water-soluble cutting fluids can be used with satisfactory result, although in some cases the durability is inferior to air-blow.



SUPPORT TOOLS FOR YOUR THREAD MILLING NEEDS

Reduce setup, machining time, and achieve stable tool life with 3 supportive tools.

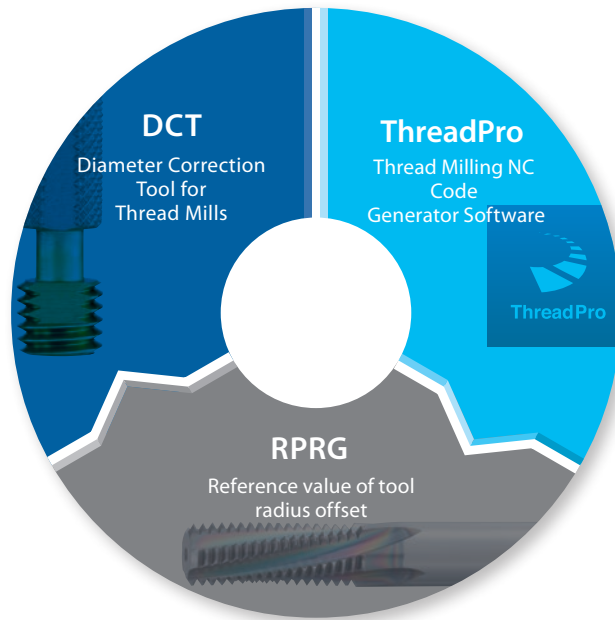

Threading | Thread milling

1 RPRG

Use RPRG to reduce the workload. RPRG is the reference value of tool radius offset.

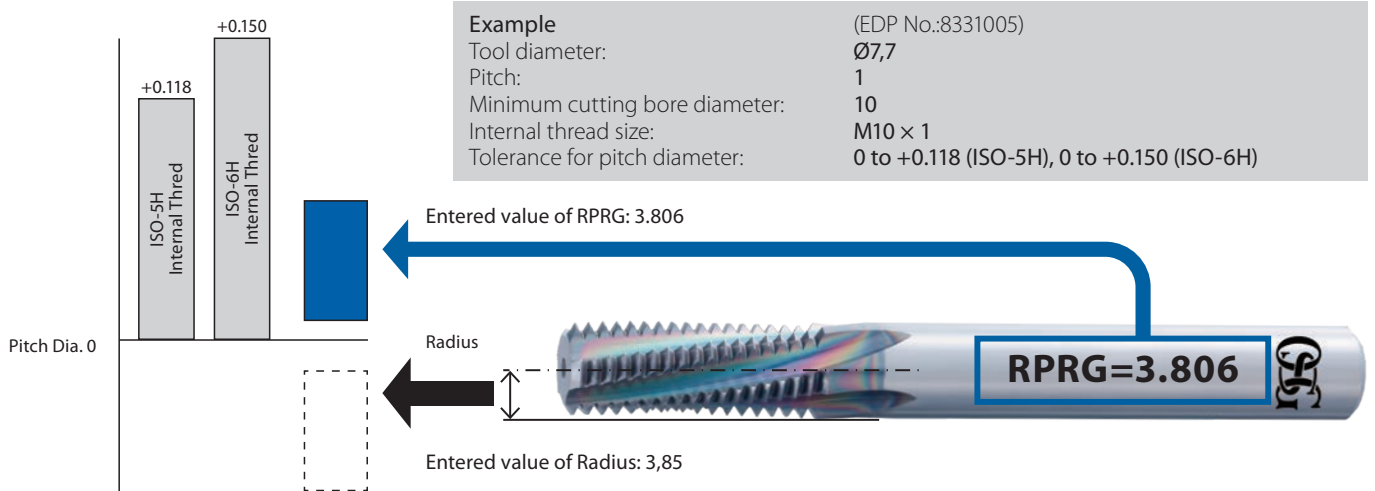

Notes

- RPRG are reference values. Optimal values for actual cutting depend on the machining environment. Determine optimal values after trial cutting.
- RPRG values are optimally established to achieve ISO:5H (formerly Grade 1) internal thread limits for metric threads and ANSI:3B internal thread limits for unified threads. RPRG values established for taper pipes (R/Rc) are effective when using the thread milling NC code generator software ThreadPro available on our website.
- For diameters of thread mills, RPRG values are calculated based on the minimum cutting bore diameter (the minimum cutting internal thread size of the tool diameter). To cut other diameters, it is necessary to use a smaller value than RPRG.

SUPPORT TOOLS FOR YOUR THREAD MILLING NEEDS

2 Revamped Thread Milling NC Code Generator Software "ThreadPro"

A more convenient Web version of ThreadPro is now available!

Generate codes for complex machining couldn't be easier. Create machining programs at ease with OSG's revamped NC code generator software ThreadPro. ThreadPro can be accessed via smartphones and PC tablets even when you are on the road without a computer.

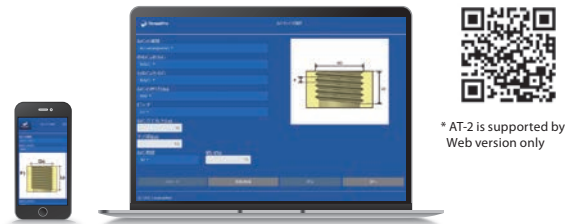

3 Achieve stable tool life with the DCT for accurate diameter measurement

The internal thread effective diameter, which used to be difficult to determine, can now be measured with readable values.

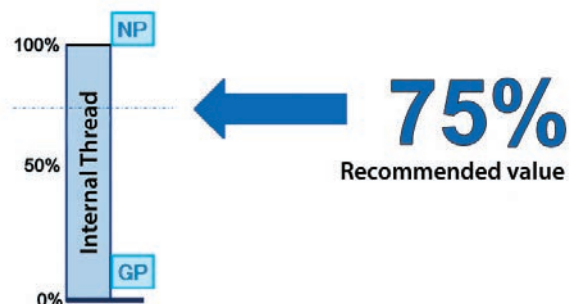

SUPPORT TOOLS FOR YOUR THREAD MILLING NEEDS

Troubled by the following problems?

Unsure of diameter correction value. Increase passes which results in longer setup time.

Visibility of internal thread pitch diameter at entry enables the reduction of passes to minimize setup time significantly.

Moreover, the DCT is able to measure pitch diameter smaller than the tolerance limit. The DCT can measure the pitch diameter of the female internal thread even if it does not fit into the Go-Gauge.

An incorrect diameter correction that result in a defective internal thread (gauge-out).

Visibility of internal thread pitch diameter at entry enables reliable diameter corrections.

The DCT is useful for reducing defective workpieces.

Unstable tool life

Digitized measurement ensures consistent internal thread pitch diameters after tool changes. The same starting and finishing position ensures consistent and stable tool life.

Solved with the Diameter Correction Tool DCT

DCT

Simple measurement of pitch diameter by visual judgment



DCT75

Low-cost type
Measurement and calculation system

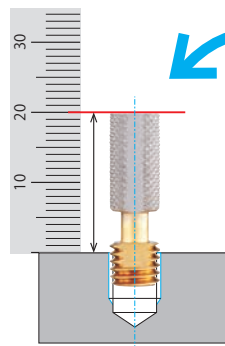

High-performance type
Digital display system

Eliminate measurement and calculation with the combination of a digital display.

AT-2 PROCESSING FAQ

Q. *What is the length of the incomplete thread part of AT-2?*

A. ThreadPro

The Zmin (processing depth) can be confirmed when creating the program with ThreadPro. The length of the incomplete thread can be calculated from the difference between “threading length (Lo)” and “Zmin (processing depth).”

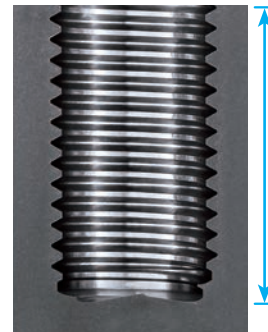

Zmin

* Since the AT-2 has an end-cutting edge and a roughing teeth specification, the length of the incomplete threaded portion may be longer than that of general thread mill.

Q. *Is the AT-2 only suitable for high hardness steels?*

A. Under appropriate machining condition, the AT-2 is suitable for a variety of materials, ranging from general steel to heat-resistant alloys and high hardness steel.

Q. *Is it possible to process a workpiece that has been quenched?*

A. Yes. Even if only the pilot hole is machined, you can still use the program created with ThreadPro to process as usual.

Q. *In the processing of high hardness materials, threading is performed before heat treatment, but the thread accuracy is not stable due to distortion caused by heat treatment. What is the countermeasure?*

A. The AT-2 can be used with work material hardness up to 65 HRC. Since threading after heat treatment is possible, stable thread accuracy of the finished product can be obtained.

Q. *Until now, different machines are used between the milling and drilling process and the tapping process. Which machine should the AT-2 be used on?*

A. Please use the machine for milling. Thread mills can be used on machinery with helical functions. The AT-2 can also be threaded at high rotational speeds, even for hard materials that are generally tapped at low rotational speeds, so they can be used on machines with high-speed spindles. In addition, the AT-2 does not require pilot holes, so the number of tools can be reduced, and processes can be consolidated.

SWEDEN

Branch office of OSG SCANDINAVIA
Abrahams Gränd 8
295 35 Bromölla
Sweden
Tel: +46 40 41 22 55
osg@osg-scandinavia.com

OSG SCANDINAVIA

(For Scandinavian countries)
Langebjergvaenget 16
4000 Roskilde
Denmark
Tel: +45 46 75 65 55
osg@osg-scandinavia.com

OSG NETHERLANDS

Bedrijfsweg 5
3481 MG Harmelen
The Netherlands
Tel: +31 348 44 2764
Fax: +31 348 44 2144
info@osg-nl.com

OSG UK

Shelton house, 5 Bentalls
Pipps Hill Ind Est, Basildon Essex SS14 3BY
United Kingdom
Tel: +44 1268 567660
Fax: +44 1268 567661
sales@osg-uk.com

OSG EUROPE LOGISTICS

Avenue Lavoisier 1
B-1300 Z.I. Wavre - Nord
Belgium
Tel: +32 10 23 05 07
Fax: +32 10 23 05 51
info@osgeurope.com

OSG BELUX

Avenue Lavoisier 1
B-1300 Z.I. Wavre - Nord
Belgium
Tel: +32 10 23 05 11
Fax: +32 10 23 05 31
info@osg-belgium.com

OSG IBÉRICA

Bekolarra 4
E - 01010 Vitoria-Gasteiz
Spain
Tel: +34 945 242 400
Fax: +34 945 228 883
osg.iberica@osg-ib.com

OSG FRANCE

Parc Icade, Paris Nord 2
Immeuble "Le Rimbaud"
22 Avenue des Nations
CS66191 - 93420 Villepinte
France
Tel: +33 1 49 90 10 10
Fax: +33 1 49 90 10 15
sales@osg-france.com

OSG ITALY

Via Ferrero, 65 A/B
I - 10098 Rivoli
Italian
Tel: +39 0117705211
Fax: +39 0117705215
info@osg-italia.it



OSG IN EUROPE

CZECH REPUBLIC, SLOVAKIA, HUNGARY

OSG Europe Logistics S. A.
Slovakia, organizačná zložka
Račianska 22/A, Bratislava 831 02
Slovakia
Tel.: +421 24 32 91 295
info@osgeurope.com

OSG POLAND

ul. Spółdzielcza 57
05-074 Halinów
Polska
Tel: +22 760 82 71
Mob. +48 570 677 711
osg@osg-poland.com

OSG RUSSIA

Butlerova street, 17B, office 5069
117342 Moscow
Russia
Tel: +7 (495) 150 41 54
info@osg-russia.com

ROMSAN INTERNATIONAL CO. SRL

Reprezentant Exclusiv OSG
25C, Bucuresti-Magurele Street
051431 Bucuresti
România
Tel: +40 21 322 07 47
Fax: +40 21 321 56 00
romsan.int@romsan.ro

OSG TURKEY

Rami Kışla Cad.No:56 Eyüp
Istanbul 34056
Turkey
Tel: +90 212 565 24 00
Fax: +90 212 565 44 00
info@osg-turkey.com

Vischer & Bolli AG

Machining and Workholding
Im Schossacher 17
CH-8600 Dübendorf
Schweiz
Tel.: +41 44 802 15 15
Fax: +41 44 802 15 95
info@vb-tools.com

OSG GERMANY

Karl-Ehmann-Str. 25
D - 73037 Göppingen
Germany
Tel: +49 7161 6064 - 0
Fax: +49 7161 6064 - 444
info@osg-germany.de



shaping your dreams

OSG EUROPE LOGISTICS

Avenue Lavoisier 1
B-1300 Z.I. Wavre - Nord - Belgium
Tel: +32 10 23 05 07
Fax: +32 10 23 05 51
info@osgeurope.com

OSG BELUX

Avenue Lavoisier 1
B-1300 Z.I. Wavre - Nord - Belgium
Tel: +32 10 23 05 11
Fax: +32 10 23 05 31
info@osg-belgium.com

OSG FRANCE

Parc Icade, Paris Nord 2
Immeuble "Le Rimbaud"
22 Avenue des Nations
CS66191 - 93420 Villepinte - France
Tel: +33 1 49 90 10 10
Fax: +33 1 49 90 10 15
sales@osg-france.com

OSG NETHERLANDS

Bedrijfsweg 5 - 3481 MG Harmelen
Tel: +31 348 44 2764
Fax: +31 348 44 2144
info@osg-nl.com

OSG UK

Shelton house, 5 Bentalls
Pipps Hill Ind Est, Basildon Essex SS14 3BY
Tel: +44 1268 567 660
Fax: +44 1268 567 661
sales@osg-uk.com

CZECH, SLOVAKIA, HUNGARY

OSG Europe Logistics S.A.
Slovakia organizacna zlozka
Racianská 22/A, SK-83102 Bratislava
Slovakia
Tel. +421 24 32 91 295
Orders-osgsvk@osgeurope.com

OSG POLAND Sp. z.o.o.

Spółdzielcza 57
05-074 Halinów - Poland
Tel: +22 760 82 71
Fax: +22 760 82 71
osg@osg-poland.com

OSG GERMANY

Karl-Ehmann-Str. 25
D - 73037 Göppingen - Germany
Tel: +49 7161 6064 - 0
Fax: +49 7161 6064 - 444
info@osg-germany.de

OSG SCANDINAVIA

(For Scandinavian countries)
Langebjergvaenget 16
4000 Roskilde - Denmark
Tel: +45 46 75 65 55
Fax: +45 46 75 67 00
osg@osg-scandinavia.com

SWEDEN

Branch office of OSG SCANDINAVIA
Abrahams Gränd 8
295 35 Bromölla - Sweden
Tel: +46 40 41 22 55
Fax: +46 40 41 32 55
osg@osg-scandinavia.com

OSG IBERICA

Bekolarra 4
E - 01010 Vitoria-Gasteiz - Spain
Tel: +34 945 242 400
Fax: +34 945 228 883
osg.iberica@osg-ib.com

RUSSIA

Butlerova street, 17B, office 5069
117342 Moscow - Russia
Tel: +7 (495) 150 41 54
info@osg-russia.com

OSG TURKEY

Rami Kişla Cad.No:56 Eyüp
Istanbul 34056 - Turkey
Tel:+90 212 565 24 00
Fax: +90 212 565 44 00
info@osg-turkey.com

ROMSAN INTERNATIONAL CO. SRL

Reprezentant Exclusiv OSG
25C, Bucuresti-Magurele Street
051431 Bucuresti - România
Tel: +40 21 322 07 47
Fax: +40 21 321 56 00
romsan.int@romsan.ro

AUSTRIA

Branch office of OSG GERMANY
Messestraße 11
A-6850 Dornbirn
Tel: +49 7161 6064-0
Fax: +49 7161 6064-444
info@osg-germany.de

OSG ITALIA

Via Ferrero, 65 A/B
I - 10098 Rivoli - Italy
Tel: +39 0117705211
Fax: +39 0117705215
info@osg-italia.it

Vischer & Bolli AG

Machining and Workholding
Im Schossacher 17
CH-8600 Dübendorf
T +41 44 802 15 15
F +41 44 802 15 95
info@vb-tools.com

OSG EUROPE LOGISTICS S.A.

07/2021 - All rights reserved. © OSG Europe 2021.

The contents of this catalogue are provided to you for viewing only. They are not intended for reproduction either in part or in whole in this or other medium. They cannot be copied, used to create derivation work or used for any reason, by means without the express, written permission of the copyright owner. If prices are stated, they are netto unit-prices and any eventual tax(es) have to be added. The company is not responsible for any printing error in technical, price and/or any other data.

Tool specifications subject to change without notice.

www.osgeurope.com