



Forming Taps for Stainless Steel and Aluminium Alloys

# M-NRT

Volume 1



## KEY FEATURES : M-NRT

---



**1** Low-torque spec with specially designed threading for Inox and aluminum

**2** TiN coating

**3** High wear resistance.  
Powder Metallurgy HSS.

# M-NRT

Threading | Forming taps | Metric



- Powder metal forming tap for through & blind holes
- TiN coating
- For general steel, stainless steels and aluminum

Type 1

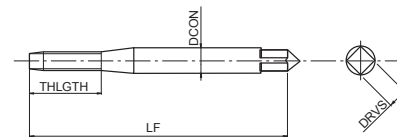

Type 2

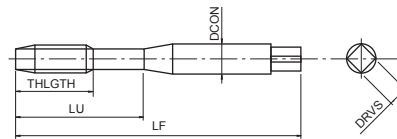

Type 3

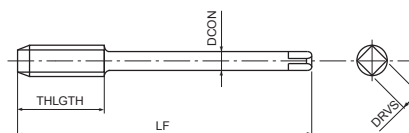

P	P	P	P	M	N	N	
C < 0,2%	0,25 < C < 0,4	C > 0,45%	SCM	INOX	Al	AC, ADC	m/min
20-30	20-30	15-30	10-20	6-12	10-25	15-40	

M	PM	TiN	ISO 2 6HX	C/2,5			DIN 2174	DIN 2174
---	----	-----	-----------	-------	--	--	----------	----------

\* Tolerance 4HX

EDP	TD	TP	LF	THLGTH	LU	DCON	DRVS	NOF	PHD	Type	DIN	Price
EP0203111*	1	0,25	40	5,5		2,5	2,1	3	0,89	1	DIN2174	
EP0203115*	1,4	0,3	40	7		2,5	2,1	3	1,27	1	DIN2174	
EP0203118	1,6	0,35	40	8		2,5	2,1	3	1,44	1	DIN2174	
EP0203125	2	0,4	45	9		2,8	2,1	3	1,82	1	DIN2174	
EP0203133	2,5	0,45	50	9	14	2,8	2,1	4	2,3	2	DIN2174	
EP0203138	3	0,5	56	10	18	3,5	2,7	4	2,8	2	DIN2174	
EP0203142	3,5	0,6	56	11	20	4	3	4	3,25	2	DIN2174	
EP0203144	4	0,7	63	12	21	4,5	3,4	4	3,7	2	DIN2174	
EP0203147	4,5	0,75	70	14	25	6	4,9	4	4,15	2	DIN2174	
EP0203149	5	0,8	70	14	25	6	4,9	5	4,65	2	DIN2174	
EP0203152	5,5	0,9	80	14	30	6	4,9	5	5,1	2	DIN2174	
EP0203155	6	1	80	16	30	6	4,9	5	5,55	2	DIN2174	
EP0203158	7	1	80	16	30	7	5,5	5	6,55	2	DIN2174	
EP0203161	8	1,25	90	18	35	8	6,2	5	7,45	2	DIN2174	
EP0203165	9	1,25	90	18	35	9	7	5	8,45	2	DIN2174	
EP0203169	10	1,5	100	20	39	10	8	5	9,35	2	DIN2174	
EP0203175	11	1,5	100	22		8	6,2	5	10,35	3	DIN2174	
EP0203179	12	1,75	110	24		9	7	5	11,2	3	DIN2174	
EP0203191	14	2	110	25		11	9	6	13,1	3	DIN2174	
EP0203202	16	2	110	27		12	9	6	15,1	3	DIN2174	
EP0203214	18	2,5	125	32		14	11	7	16,8	3	DIN2174	
EP0203228	20	2,5	140	32		16	12	7	18,8	3	DIN2174	
EP0203238	22	2,5	140	32		18	14,5	7	20,8	3	DIN2174	
EP0203247	24	3	160	36		18	14,5	7	22,6	3	DIN2174	



# M-NRT 6GX

Threading | Forming taps | Metric



- Powder metal forming tap for through & blind holes
- TiN coating
- For general steel, stainless steels and aluminum
- For 6G internal thread tolerance

Type 1

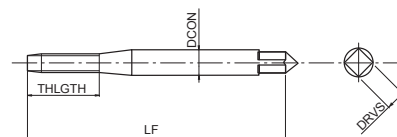

Type 2

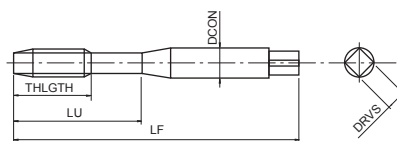

Type 3

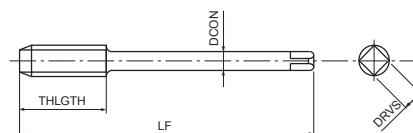

<b>P</b>	<b>P</b>	<b>P</b>	<b>P</b>	<b>M</b>	<b>N</b>	<b>N</b>	
C < 0,2%	0,25 < C < 0,4	C > 0,45%	SCM	INOX	Al	AC,ADC	
20-30	20-30	15-30	10-20	6-12	10-25	15-40	m/min

M	PM	TiN	ISO 3 6GX	C/2,5			DIN 2174
---	----	-----	-----------	-------	--	--	----------

EDP	TD	TP	oversize	LF	THLGTH	LU	DCON	DRVS	NOF	PHD	Type	DIN	Price
EP0204125	2	0,4	0,019	45	9		2,8	2,1	3	1,82	1	DIN2174	
EP0204133	2,5	0,45	0,020	50	9	14	2,8	2,1	4	2,3	2	DIN2174	
EP0204138	3	0,5	0,020	56	10	18	3,5	2,7	4	2,8	2	DIN2174	
EP0204142	3,5	0,6	0,021	56	11	20	4	3	4	3,25	2	DIN2174	
EP0204144	4	0,7	0,022	63	12	21	4,5	3,4	4	3,7	2	DIN2174	
EP0204149	5	0,8	0,024	70	14	25	6	4,9	5	4,65	2	DIN2174	
EP0204155	6	1	0,026	80	16	30	6	4,9	5	5,55	2	DIN2174	
EP0204161	8	1,25	0,028	90	18	35	8	6,2	5	7,45	2	DIN2174	
EP0204169	10	1,5	0,032	100	20	39	10	8	5	9,35	2	DIN2174	
EP0204179	12	1,75	0,034	110	24		9	7	5	11,2	3	DIN2174	
EP0204191	14	2	0,038	110	25		11	9	6	13,1	3	DIN2174	
EP0204202	16	2	0,038	110	27		12	9	6	15,1	3	DIN2174	



# M-NRT FORM E

Threading | Forming taps | Metric

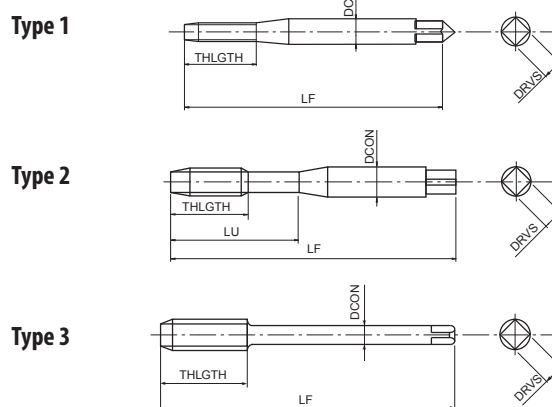

- Powder metal forming tap for through & blind holes
- TiN coating
- For general steel, stainless steels and aluminum
- Chamfer Form E

Threading | Forming taps

<b>P</b> C < 0,2%	<b>P</b> 0,25 < C < 0,4	<b>P</b> C > 0,45%	<b>P</b> SCM	<b>M</b> INOX	<b>N</b> Al	<b>N</b> AC,ADC	
20-30	20-30	15-30	10-20	6-12	10-25	15-40	m/min

<b>M</b>	<b>PM</b>	<b>TiN</b>	<b>ISO 2 6HX</b>	<b>E/1,5</b>	<b>DIN 2174</b>	<b>DIN 2174</b>
----------	-----------	------------	------------------	--------------	-----------------	-----------------

EDP	TD	TP	LF	THLGTH	LU	DCON	DRVS	NOF	PHD	Type	DIN	Price
EP0205125	2	0,4	45	9		2,8	2,1	3	1,82	1	DIN2174	
EP0205133	2,5	0,45	50	9	14	2,8	2,1	4	2,3	2	DIN2174	
EP0205138	3	0,5	56	10	18	3,5	2,7	4	2,8	2	DIN2174	
EP0205142	3,5	0,6	56	11	20	4	3	4	3,25	2	DIN2174	
EP0205144	4	0,7	63	12	21	4,5	3,4	4	3,7	2	DIN2174	
EP0205149	5	0,8	70	14	25	6	4,9	5	4,65	2	DIN2174	
EP0205155	6	1	80	16	30	6	4,9	5	5,55	2	DIN2174	
EP0205161	8	1,25	90	18	35	8	6,2	5	7,45	2	DIN2174	
EP0205169	10	1,5	100	20	39	10	8	5	9,35	2	DIN2174	
EP0205179	12	1,75	110	24		9	7	5	11,2	3	DIN2174	
EP0205191	14	2	110	25		11	9	6	13,1	3	DIN2174	
EP0205202	16	2	110	27		12	9	6	15,1	3	DIN2174	

Metric

# M-OIL-NRT FORM E

Threading | Forming taps | Metric



Type 1

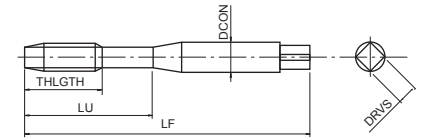

Type 2

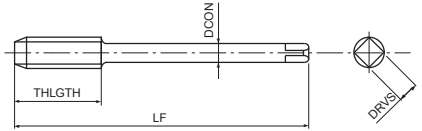

- Powder metal forming tap for blind holes
- TiN coating
- For general steel, stainless steels and aluminum
- Chamfer Form E, center through coolant

C <0,2%	0,25<C<0,4	C>0,45%	SCM	INOX	AI	AC,ADC	
20-30	20-30	15-30	10-20	6-12	10-25	15-40	m/min

M	PM	TiN	ISO 2 6HX	E/1,5	CUT	DIN 2174	DIN 2174
---	----	-----	-----------	-------	-----	----------	----------

EDP	TD	TP	LF	THLGTH	LU	DCON	DRVS	NOF	PHD	Type	DIN	Price
EP0207149	5	0,8	70	14	25	6	4,9	5	4,65	1	DIN2174	
EP0207155	6	1	80	16	30	6	4,9	5	5,55	1	DIN2174	
EP0207161	8	1,25	90	18	35	8	6,2	5	7,45	1	DIN2174	
EP0207169	10	1,5	100	20	39	10	8	5	9,35	1	DIN2174	
EP0207179	12	1,75	110	24	-	9	7	5	11,2	2	DIN2174	
EP0207191	14	2	110	25	-	11	9	6	13,1	2	DIN2174	
EP0207202	16	2	110	27	-	12	9	6	15,1	2	DIN2174	

Threading | Forming taps



Metric

# M-NRT

Threading | Forming taps | Metric Fine



Type 1

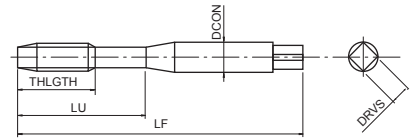

Type 2

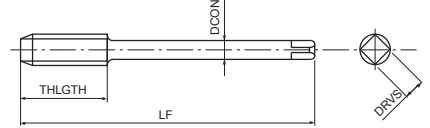

- Powder metal forming tap for through & blind holes
- TiN coating
- For general steel, stainless steels and aluminum

Threading | Forming taps

Material selection icons: P (C < 0,2%), P (0,25 < C < 0,4), P (C > 0,45%), P (SCM), M (INOX), N (Al), N (AC, ADC), speed m/min, and coating/finish options: MF, PM, TiN, ISO 2 6HX, C/2,5, and DIN 2174.

Metric Fine

EDP	TD	TP	LF	THLGTH	LU	DCON	DRVS	NOF	PHD	Type	DIN	Price
EP0203145	4	0,5	63	8	21	4,5	3,4	4	3,8	1	DIN2174	
EP0203151	5	0,5	70	9	25	6	4,9	5	4,8	1	DIN2174	
EP0203157	6	0,5	80	10	30	6	4,9	5	5,8	1	DIN2174	
EP0203156	6	0,75	80	14	30	6	4,9	5	5,65	1	DIN2174	
EP0203160	7	0,75	80	14	30	7	5,5	5	6,65	1	DIN2174	
EP0203164	8	0,5	80	10	35	8	6,2	5	7,775	1	DIN2174	
EP0203163	8	0,75	80	14	35	8	6,2	5	7,65	1	DIN2174	
EP0203162	8	1	90	18	35	8	6,2	5	7,55	1	DIN2174	
EP0203171	10	1	90	18	39	10	8	5	9,55	1	DIN2174	
EP0203170	10	1,25	100	20	39	10	8	5	9,45	1	DIN2174	
EP0203182	12	1	100	22		9	7	5	11,55	2	DIN2174	
EP0203181	12	1,25	100	22		9	7	5	11,45	2	DIN2174	
EP0203180	12	1,5	100	22		9	7	5	11,35	2	DIN2174	
EP0203194	14	1	100	22		11	9	6	13,55	2	DIN2174	
EP0203193	14	1,25	100	22		11	9	6	13,45	2	DIN2174	
EP0203192	14	1,5	100	22		11	9	6	13,35	2	DIN2174	
EP0203204	16	1	100	20		12	9	6	15,55	2	DIN2174	
EP0203203	16	1,5	100	20		12	9	6	15,35	2	DIN2174	
EP0203218	18	1	110	25		14	11	7	17,55	2	DIN2174	
EP0203216	18	1,5	110	25		14	11	7	17,35	2	DIN2174	
EP0203232	20	1	125	25		16	12	7	19,55	2	DIN2174	
EP0203230	20	1,5	125	25		16	12	7	19,35	2	DIN2174	
EP0203240	22	1,5	125	25		18	14,5	7	21,35	2	DIN2174	
EP0203250	24	1,5	140	28		18	14,5	7	23,35	2	DIN2174	





## SWEDEN

Branch office of OSG SCANDINAVIA  
Abrahams Gränd 8  
295 35 Bromölla  
Sweden  
Tel: +46 40 41 22 55  
osg@osg-scandinavia.com

## OSG SCANDINAVIA

(For Scandinavian countries)  
Langebjergvaenget 16  
4000 Roskilde  
Denmark  
Tel: +45 46 75 65 55  
osg@osg-scandinavia.com

## OSG NETHERLANDS

Bedrijfsweg 5  
3481 MG Harmelen  
The Netherlands  
Tel: +31 348 44 2764  
Fax: +31 348 44 2144  
info@osg-nl.com

## OSG UK

Shelton house, 5 Bentalls  
Pipps Hill Ind Est, Basildon Essex SS14 3BY  
United Kingdom  
Tel: +44 1268 567660  
Fax: +44 1268 567661  
sales@osg-uk.com

## OSG EUROPE LOGISTICS

Avenue Lavoisier 1  
B-1300 Z.I. Wavre - Nord  
Belgium  
Tel: +32 10 23 05 07  
Fax: +32 10 23 05 51  
info@osgeurope.com

## OSG BELUX

Avenue Lavoisier 1  
B-1300 Z.I. Wavre - Nord  
Belgium  
Tel: +32 10 23 05 11  
Fax: +32 10 23 05 31  
info@osg-belgium.com

## OSG IBÉRICA

Bekolarra 4  
E - 01010 Vitoria-Gasteiz  
Spain  
Tel: +34 945 242 400  
Fax: +34 945 228 883  
osg.iberica@osg-ib.com

## OSG FRANCE

Parc Icade, Paris Nord 2  
Immeuble "Le Rimbaud"  
22 Avenue des Nations  
CS66191 - 93420 Villepinte  
France  
Tel: +33 1 49 90 10 10  
Fax: +33 1 49 90 10 15  
sales@osg-france.com

## OSG ITALY

Via Ferrero, 65 A/B  
I - 10098 Rivoli  
Italian  
Tel: +39 0117705211  
Fax: +39 0117705215  
info@osg-italia.it



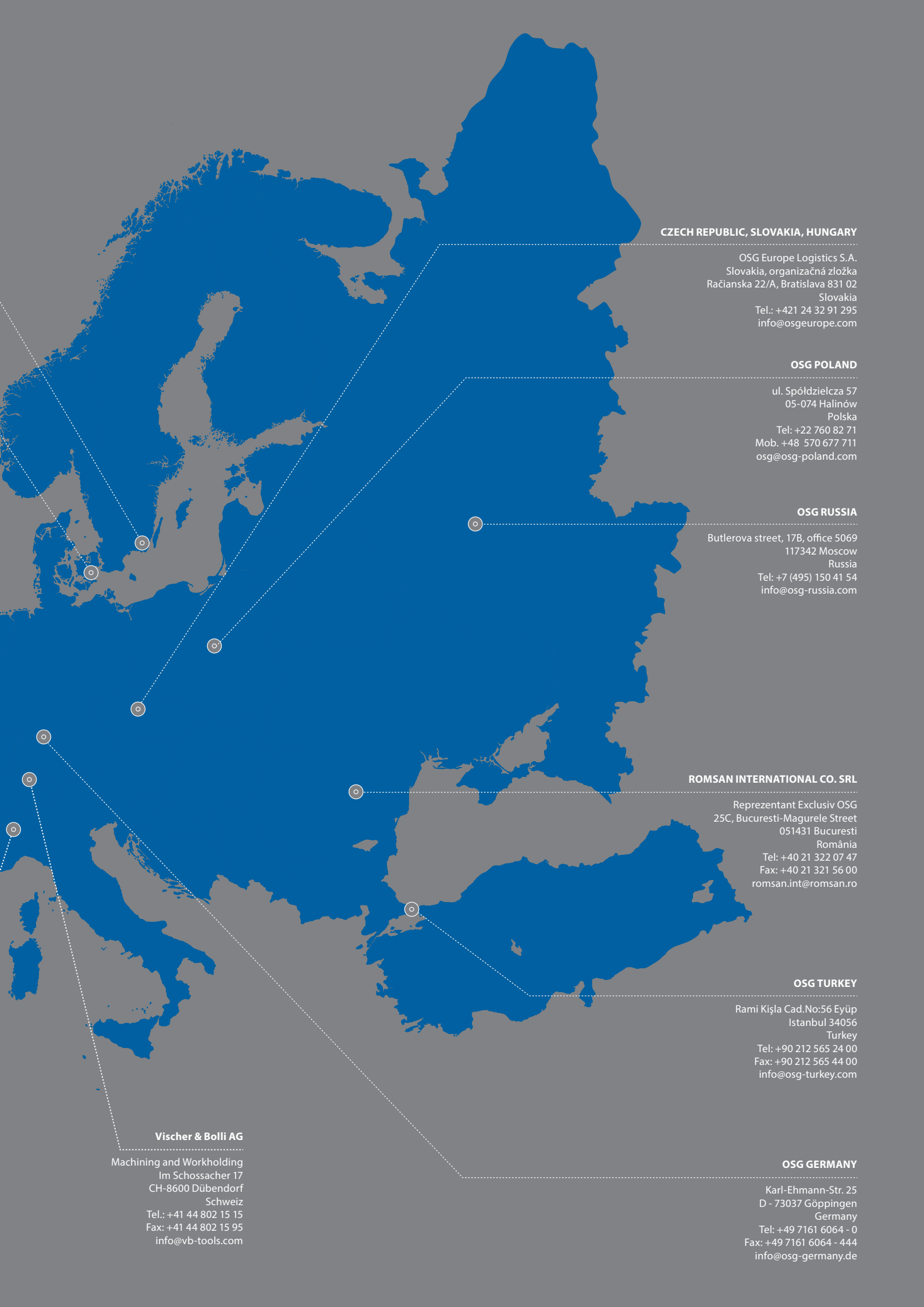

**CZECH REPUBLIC, SLOVAKIA, HUNGARY**

OSG Europe Logistics S.A.  
Slovakia, organizačná zložka  
Račianska 22/A, Bratislava 831 02  
Slovakia  
Tel.: +421 24 32 91 295  
info@osgeurope.com

**OSG POLAND**

ul. Spółdzielcza 57  
05-074 Halinów  
Polska  
Tel: +22 760 82 71  
Mob. +48 570 677 711  
osg@osg-poland.com

**OSG RUSSIA**

Butlerova street, 17B, office 5069  
117342 Moscow  
Russia  
Tel: +7 (495) 150 41 54  
info@osg-russia.com

**ROMSAN INTERNATIONAL CO. SRL**

Reprezentant Exclusiv OSG  
25C, Bucuresti-Magurele Street  
051431 Bucuresti  
România  
Tel: +40 21 322 07 47  
Fax: +40 21 321 56 00  
romsan.int@romsan.ro

**OSG TURKEY**

Rami Kişla Cad.No:56 Eyüp  
Istanbul 34056  
Turkey  
Tel: +90 212 565 24 00  
Fax: +90 212 565 44 00  
info@osg-turkey.com

**Vischer & Bolli AG**

Machining and Workholding  
Im Schossacher 17  
CH-8600 Dübendorf  
Schweiz  
Tel.: +41 44 802 15 15  
Fax: +41 44 802 15 95  
info@vb-tools.com

**OSG GERMANY**

Karl-Ehmann-Str. 25  
D - 73037 Göppingen  
Germany  
Tel: +49 7161 6064 - 0  
Fax: +49 7161 6064 - 444  
info@osg-germany.de



shaping your dreams

#### **OSG EUROPE LOGISTICS**

Avenue Lavoisier 1  
B-1300 Z.I. Wavre - Nord - Belgium  
Tel: +32 10 23 05 07  
Fax: +32 10 23 05 51  
info@osgeurope.com

#### **OSG BELUX**

Avenue Lavoisier 1  
B-1300 Z.I. Wavre - Nord - Belgium  
Tel: +32 10 23 05 11  
Fax: +32 10 23 05 31  
info@osg-belgium.com

#### **OSG FRANCE**

Parc Icade, Paris Nord 2  
Immeuble "Le Rimbaud"  
22 Avenue des Nations  
CS66191 - 93420 Villepinte - France  
Tel: +33 1 49 90 10 10  
Fax: +33 1 49 90 10 15  
sales@osg-france.com

#### **OSG NETHERLANDS**

Bedrijfsweg 5 - 3481 MG Harmelen  
Tel: +31 348 44 2764  
Fax: +31 348 44 2144  
info@osg-nl.com

#### **OSG UK**

Shelton house, 5 Bentalls  
Pipps Hill Ind Est, Basildon Essex SS14 3BY  
Tel: +44 1268 567 660  
Fax: +44 1268 567 661  
sales@osg-uk.com

#### **CZECH, SLOVAKIA, HUNGARY**

OSG Europe Logistics S.A.  
Slovakia organizacna zlozka  
Racianská 22/A, SK-83102 Bratislava  
Slovakia  
Tel. +421 24 32 91 295  
Orders-osgsvk@osgeurope.com

#### **OSG POLAND Sp. z.o.o.**

Spółdzielcza 57  
05-074 Halinów - Poland  
Tel: +22 760 82 71  
Fax: +22 760 82 71  
osg@osg-poland.com

#### **OSG GERMANY**

Karl-Ehmann-Str. 25  
D - 73037 Göppingen - Germany  
Tel: +49 7161 6064 - 0  
Fax: +49 7161 6064 - 444  
info@osg-germany.de

#### **OSG SCANDINAVIA**

(For Scandinavian countries)  
Langebjergvaenget 16  
4000 Roskilde - Denmark  
Tel: +45 46 75 65 55  
Fax: +45 46 75 67 00  
osg@osg-scandinavia.com

#### **SWEDEN**

Branch office of OSG SCANDINAVIA  
Abrahams Gränd 8  
295 35 Bromölla - Sweden  
Tel: +46 40 41 22 55  
Fax: +46 40 41 32 55  
osg@osg-scandinavia.com

#### **OSG IBERICA**

Bekolarra 4  
E - 01010 Vitoria-Gasteiz - Spain  
Tel: +34 945 242 400  
Fax: +34 945 228 883  
osg.iberica@osg-ib.com

#### **RUSSIA**

Butlerova street, 17B, office 5069  
117342 Moscow - Russia  
Tel: +7 (495) 150 41 54  
info@osg-russia.com

#### **OSG TURKEY**

Rami Kişla Cad.No:56 Eyüp  
Istanbul 34056 - Turkey  
Tel:+90 212 565 24 00  
Fax: +90 212 565 44 00  
info@osg-turkey.com

#### **ROMSAN INTERNATIONAL CO. SRL**

Reprezentant Exclusiv OSG  
25C, Bucuresti-Magurele Street  
051431 Bucuresti - România  
Tel: +40 21 322 07 47  
Fax: +40 21 321 56 00  
romsan.int@romsan.ro

#### **AUSTRIA**

Branch office of OSG GERMANY  
Messestraße 11  
A-6850 Dornbirn  
Tel: +49 7161 6064-0  
Fax: +49 7161 6064-444  
info@osg-germany.de

#### **OSG ITALIA**

Via Ferrero, 65 A/B  
I - 10098 Rivoli - Italy  
Tel: +39 0117705211  
Fax: +39 0117705215  
info@osg-italia.it

#### **Vischer & Bolli AG**

Machining and Workholding  
Im Schossacher 17  
CH-8600 Dübendorf  
T +41 44 802 15 15  
F +41 44 802 15 95  
info@vb-tools.com

**OSG EUROPE LOGISTICS S.A.**

10/2021 - All rights reserved. © OSG Europe 2021.

The contents of this catalogue are provided to you for viewing only. They are not intended for reproduction either in part or in whole in this or other medium. They cannot be copied, used to create derivation work or used for any reason, by means without the express, written permission of the copyright owner. If prices are stated, they are netto unit-prices and any eventual tax(es) have to be added. The company is not responsible for any printing error in technical, price and/or any other data.

Tool specifications subject to change without notice.

[www.osgeurope.com](http://www.osgeurope.com)

