

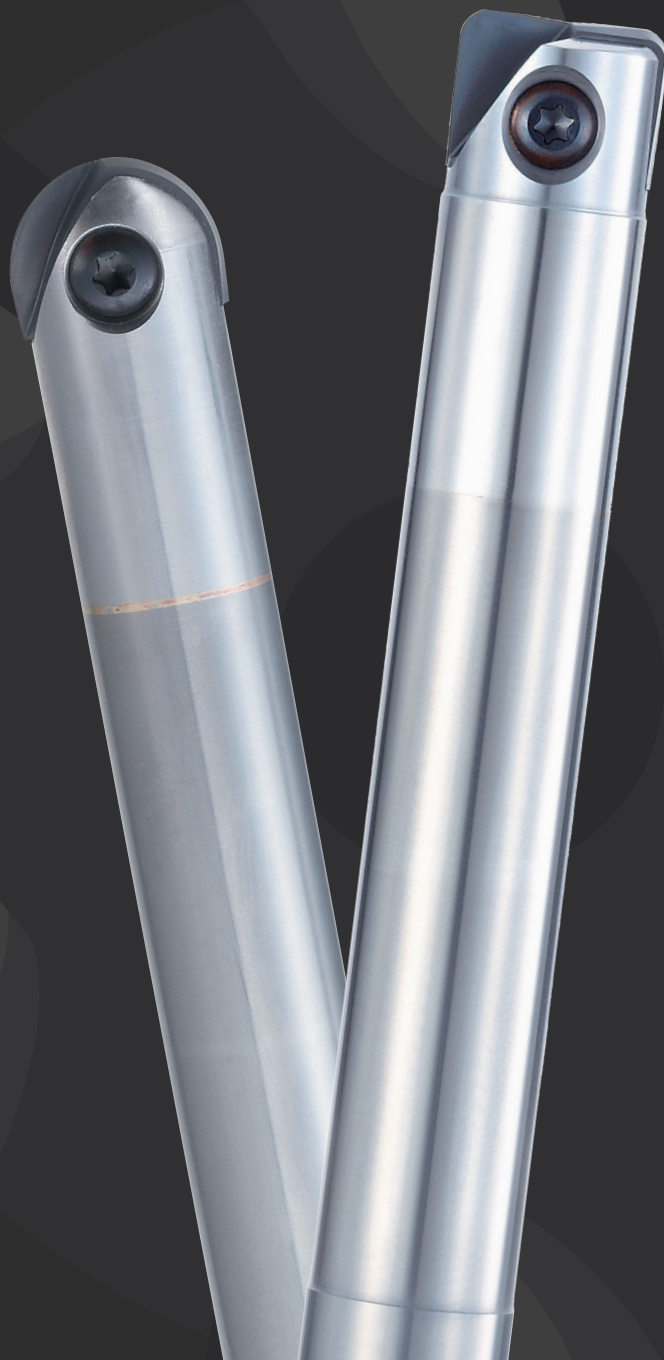

Finishing Ball & Radius End Mill

PFB PFR

Volume 4



FEATURES: PHOENIX PFB

1 Indexable insert

2 2 flutes

3 Short, long & extra long

4 Ball nose cutter for finishing

5 Carbide shank

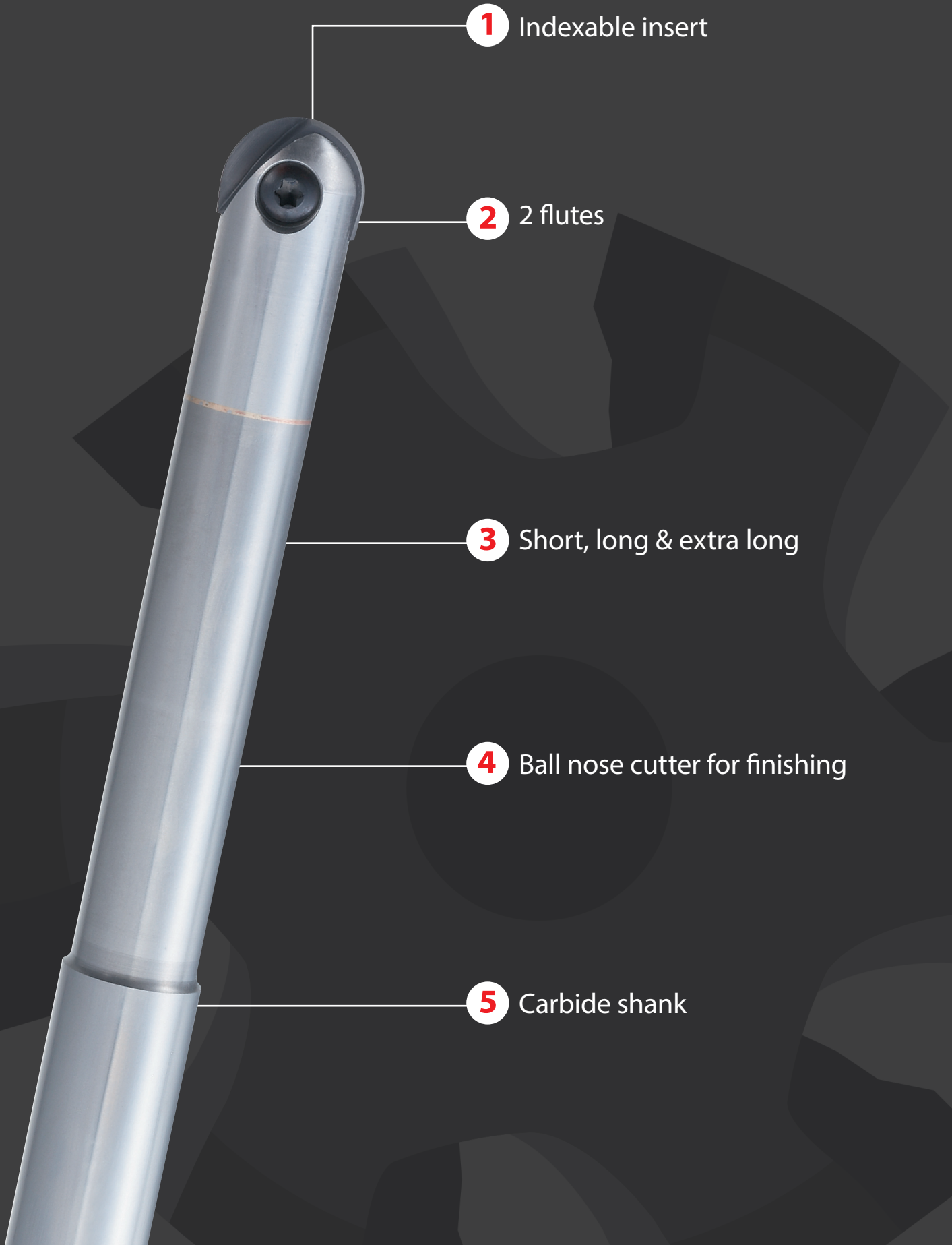

PFB INSERTS

Milling | Indexables

High Radius precision

Spiral cutting edge with excellent sharpness

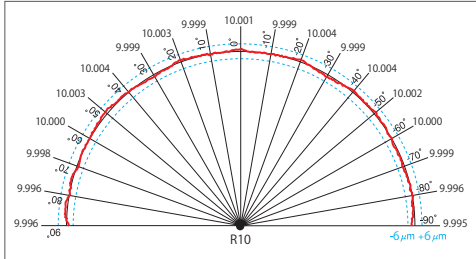

Type

Grade

PFB-SP

- Applicable to a wide variety of work materials from mild steel to HRSA
- Sharp but rigid cutting edge
- Excellent chipping resistance

XP3320 Grade

- For dry milling of steel, stainless steel, and cast iron
- For wet milling of HRSA

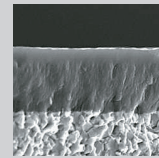

→ Heat resistant coating
→ Wear resistant coating

PFB-Q

- Applicable to undercuts with 220° effective cutting edge angle
- No straight cutting edge at the outer peripheral surface, which is applicable to standing wall milling that occurs chattering

XP3225 Grade

- For stable milling of a wide variety of work materials
- Excellent lubricity and wear resistance
- For wet milling of steel and stainless steel

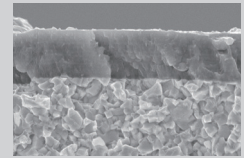

PFB-Q-ST

- Applicable to undercuts with 200°- 220° effective cutting edge section
- Excellent wear resistance with its high rigidity cutting geometry
- Straight type (full radius type)

XP2225 Grade

- For stainless steel and HRSA
- Excellent heat resistance

PFB-SH

- For milling cast iron, ductile iron and HRSA
- Strong cutting edge by the special processing
- Highly resistant carbide material

XP3310 Grade

- Ideal for dry milling of high hardened steel and cast iron
- Excellent heat and wear resistance

NEW

PFB-HH

- Specifications specialized for high-hardness steels by combining a special base material and the DURORAY coating
- Special cutting edge treatment improves chipping resistance and machined surface accuracy

NEW

XP6703 Grade

- For high hardness steel and cast iron
- Excellent wear resistance

PFB-D

- Sharp cutting edge specialized for milling graphite
- Highly adhesive carbide material for diamond coating

XC4505 Grade

- For milling nonferrous material
- Optimal diamond coating for milling graphite

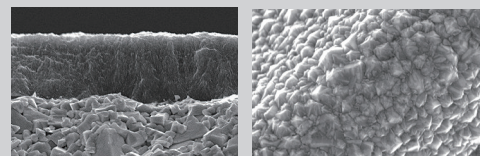

CUTTING DATA

Milling | Indexables

Finishing of turbine blade with the XP2225

Tool	PFB160-Q-ST (XP2225)	Competitor
Insert (grade)	PFB160-Q-ST (XP2225)	Coated carbide insert
Work	Turbine Blade (Cutting length 487 m / per blade)	
Work Material	SUS430	
Cutting Speed	420m/min(8.350min ⁻¹)	
Feed	6.687mm/min(0,24mm/t)	
Depth of Cut	ap=0,2mm pf=0,5mm	
Coolant	Water soluble	
Machine	5-axis machine exclusive for blade machining	

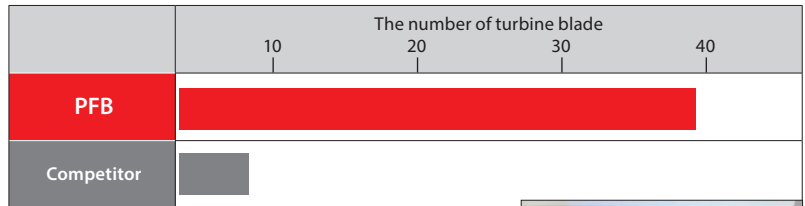

Achieved high-speed milling without chipping by the newly designed cutting geometry. Durability has also greatly increased due to the new material grade.

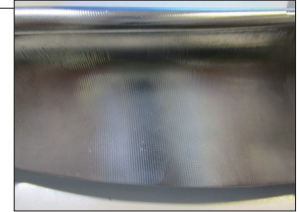

Finishing milling on large press die of FCD700

Tool	PFB-R300SS32-LL290CS (R15X2)
Insert (grade)	PFB300-SH (XP3310)
Work	Side panel outer
Work Material	GGG70L (FCD700) Equivalent
Cutting Speed	565m/min(6.000min ⁻¹)
Feed	5.600mm/min(0,47mm/t)
Cutting method	Profiling milling
Depth of Cut	ap=0,17mm pf=0,5mm
Coolant	Air Blow
Machine	Double column machining center

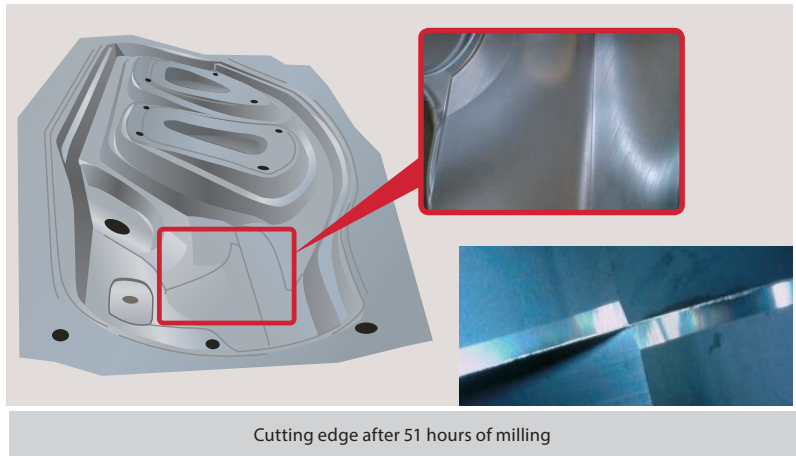

Reasonable wear and no chipping of cutting edge occurred after 51 hours of machining. All points of the work material met the required form accuracy, and the shiny machined surface was achieved.

Surprising durability of the diamond coating

Tool	PFB-R250SS25-S160 (R12,5X2)	
Insert (grade)	PFB250-SP (XP3320)	PFB250-D (XC4505)
Work Material	Graphite	
Cutting Speed	220m/min(2.800min ⁻¹)	
Feed	560mm/min(0,1mm/t)	
Cutting method	Pick milling	
Depth of Cut	ap=12,5mm pf=0,2mm	
Coolant	None	
Machine	Vertical machining center	

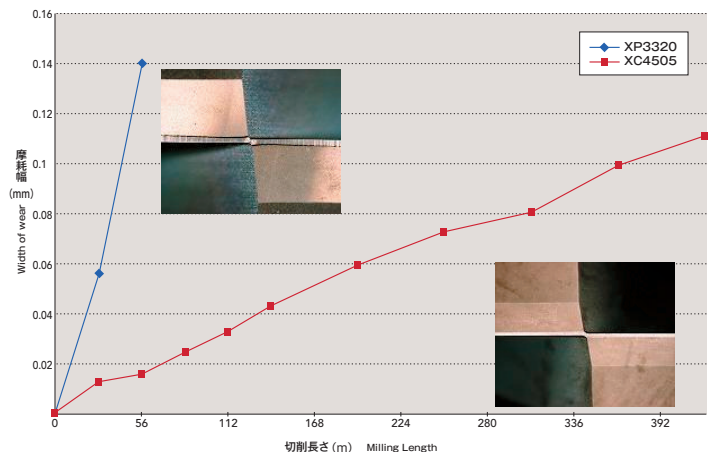

Diamond coating showed its superiority in machining graphite.

CUTTING DATA

Milling | Indexables

Milling of a SUH600 blade (comparison of tool wear)

Tool	PFB-R200SS20-S160 (R10x2)
Insert (grade)	PFB200-SP (XP3320)
Work	Blade sample model
Work Material	SUH600 Equivalent
Overhang length	110mm
Cutting Speed	94m/min(1.500min ⁻¹)
Feed	2.000mm/min(0,67mm/t)
Cutting method	Profile milling
Depth of Cut	a _p =0,2mm p _f =1mm
Coolant	Water soluble
Machine	Vertical machining center

Time	70 minutes		140 minutes	
Milling Length	100m		200m	
PFB				
	(mm) Wear amount	0,033	0,030	0,041
Competitor				
	(mm) Wear amount	0,032	0,033	0,070

R300 Work piece top surface

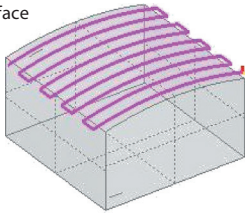

In comparison to competitor products, the PFB has half the amount of tooling wear after machining 200m.

S50C at 30° inclined surface machine

Tool	PFB-R200SS20-S160 (R10x2)
Insert (grade)	PFB200-SP (XP3325)
Work Material	S50C
Overhang length	80mm
Cutting Speed	300m/min(4.800min ⁻¹)
Feed	1.344mm/min(0,14mm/t)
Cutting method	Straight line pick 30° inclinasion
Depth of Cut	a _p =0,1mm p _f =0,5mm
Coolant	Air blow
Machine	Horizontal machining center

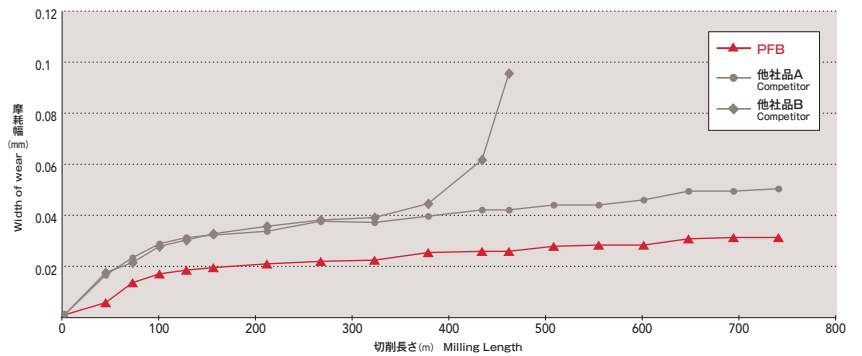

The XP3325 is capable of achieving stable machining without abrupt interruptions and tool chipping. In comparison to competitor products, tooling wear on the XP3325 in the initial machining stage was minimal.

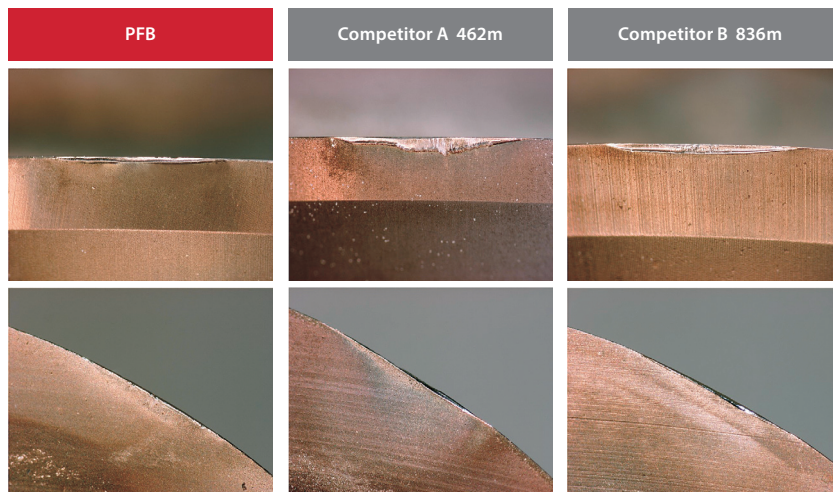

CUTTING DATA

Milling | Indexables

Machining die insert with FC250

Tool	PFB-R200SS20-LL240CS (R10x2)
Insert (grade)	PFB200-SH (XP3310)
Work	Die insert
Work Material	FC250
Overhang length	160mm
Cutting Speed	345m/min(5.500min ⁻¹)
Feed	4.000mm/min(0,36mm/t)
Cutting method	Profile milling, contour milling
Depth of Cut	a _p =0,2mm p _f =0,25mm
Coolant	Air blow
Machine	Vertical machining center

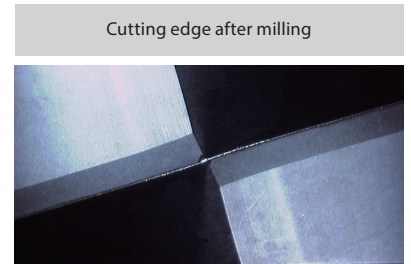

The finished surface and accuracy increased compared by the competition.

Machining graphite electrode with PFB-D

Tool	PFB-R160SS16-LL200CS (R8x2)	PFB-R080ss08-LL140CS (R4x2)
Insert (grade)	PFB160-D (XC4505)	PFB080-D (XC4505)
Work Material	Graphite electrode	
Overhang length	120mm (7,5D)	110mm (13,75D)
Cutting Speed	400m/min(8.000min ⁻¹)	100m/min(4.000min ⁻¹)
Feed	8.000mm/min (0,5mm/t)	2.160mm/min (0,27mm/t)
Cutting method	Profile and contour milling	
Depth of Cut	a _p =8mm p _f =12mm	a _p =0,3mm p _f =0,24mm
Coolant	None	
Machine	Vertical machining center	

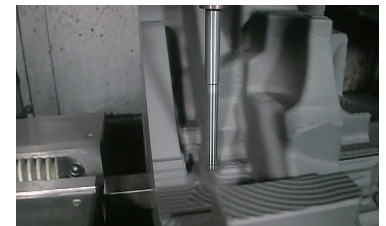
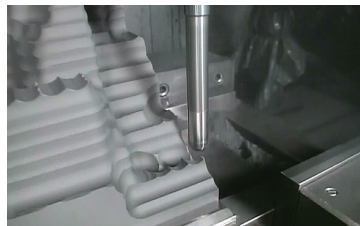

Reasonable wear and no chipping of cutting edge occurred after 51 hours of machining. All points of the work material met the required form accuracy, and the shiny machined surface was achieved.



Die insert with SKD11

Tool	PFB-R100SS10-LL150CS (R5X2)
Insert (grade)	PFB100-SP (XP3320)
Work	Die insert
Work Material	SKD11 (58HRC) Equivalent
Overhang Length	80mm
Cutting Speed	200m/min(8.000min ⁻¹)
Feed	2.000mm/min(0,125mm/t)
Cutting method	Profile milling, Contour milling
Depth of Cut	a _p =0,1mm p _f =0,2mm
Coolant	Air blow
Machine	Vertical machining center



Cutting edge had normal wear without abnormal damage after finishing 7 hours of machining. Finished surface was much smoother and consistant versus competition.

Diamond coating showed its superiority in machining graphite.

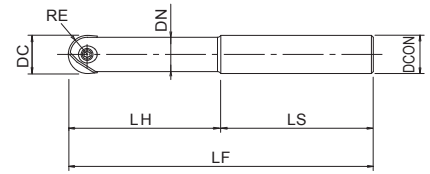

- Finishing ball nose cutter
- Excellent sharpness
- Cylindrical type
- 6 - 32 mm

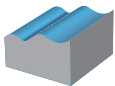

EDP	Designation	ZEFP	DC	RE	LF	LH	DCON	DN	LS	ULDR	Seat size	Specification
7801429	PFB-R060SS06-S80CS	2	6	3	80	15	6	5,4	65	2,5	1	Carbide
7801439	PFB-R060SS06-L100CS	2	6	3	100	30	6	5,4	70	5	1	Carbide
7801419	PFB-R060SS06-LL120CS	2	6	3	120	42	6	5,4	78	7	1	Carbide
7801430	PFB-R080SS08-S100CS	2	8	4	100	20	8	7	80	2,5	2	Carbide
7801440	PFB-R080SS08-L120CS	2	8	4	120	40	8	7	80	5	2	Carbide
7801420	PFB-R080SS08-LL140CS	2	8	4	140	56	8	7	84	7	2	Carbide
7801431	PFB-R100SS10-S100CS	2	10	5	100	25	10	9	75	2,5	3	Carbide
7801441	PFB-R100SS10-L130CS	2	10	5	130	50	10	9	80	5	3	Carbide
7801421	PFB-R100SS10-LL150CS	2	10	5	150	70	10	9	80	7	3	Carbide
7801432	PFB-R120SS12-S110CS	2	12	6	110	30	12	11	80	2,5	4	Carbide
7801442	PFB-R120SS12-L140CS	2	12	6	140	60	12	11	80	5	4	Carbide
7801422	PFB-R120SS12-LL160CS	2	12	6	160	84	12	11	76	7	4	Carbide
7801433	PFB-R160SS16-S140CS	2	16	8	140	40	16	14	100	2,5	5	Carbide
7801443	PFB-R160SS16-L160CS	2	16	8	160	72	16	14	88	4,5	5	Carbide
7801423	PFB-R160SS16-LL200CS	2	16	8	200	96	16	14	104	6	5	Carbide
7801434	PFB-R200SS20-S160CS	2	20	10	160	50	20	18	110	2,5	6	Carbide
7801444	PFB-R200SS20-L180CS	2	20	10	180	90	20	18	90	4,5	6	Carbide
7801424	PFB-R200SS20-LL240CS	2	20	10	240	120	20	18	120	6	6	Carbide
7801435	PFB-R250SS25-S160CS	2	25	12,5	160	62,5	25	22	97,5	2,5	7	Carbide
7801445	PFB-R250SS25-L200CS	2	25	12,5	200	100	25	22	100	4	7	Carbide
7801425	PFB-R250SS25-LL260CS	2	25	12,5	260	137,5	25	22	122,5	5,5	7	Carbide
7801436	PFB-R300SS32-S170CS	2	30	15	170	75	32	27	95	2,5	8	Carbide
7801446	PFB-R300SS32-L220CS	2	30	15	220	120	32	27	100	4	8	Carbide
7801426	PFB-R300SS32-LL290CS	2	30	15	290	165	32	27	125	5,5	8	Carbide
7801437	PFB-R320SS32-S180CS	2	32	16	180	80	32	29	100	2,5	9	Carbide
7801447	PFB-R320SS32-L230CS	2	32	16	230	128	32	29	102	4	9	Carbide
7801427	PFB-R320SS32-LL300CS	2	32	16	300	176	32	29	124	5,5	9	Carbide
7801400	PFB-R080SS08-S120	2	8	4	120	36	8	7	84	4,5	2	Steel
7801401	PFB-R100SS10-S130	2	10	5	130	45	10	9	85	4,5	3	Steel
7801402	PFB-R120SS12-S130	2	12	6	130	54	12	11	76	4,5	4	Steel
7801403	PFB-R160SS16-S140	2	16	8	140	64	16	14	76	4	5	Steel
7801404	PFB-R200SS20-S160	2	20	10	160	80	20	18	80	4	6	Steel
7801405	PFB-R250SS25-S160	2	25	12,5	160	75	25	22	85	3	7	Steel
7801406	PFB-R300SS32-S170	2	30	15	170	90	32	27	80	3	8	Steel
7801407	PFB-R320SS32-S180	2	32	16	180	96	32	29	84	3	9	Steel

Accessories and spare parts

Applicable cutter DC	EDP	Designation	Torque	Specification
6	7808124	FS20652RB	0,8 N.m	Clamping screw
8	7808123	FS25669RB	1,0 N.m	Clamping screw
10	7808117	FS30686RB	1,2 N.m	Clamping screw
12	7808118	FS35610RB	2,0 N.m	Clamping screw
16	7808119	FS40613RB	3,0 N.m	Clamping screw
20	7808120	FS50615RB	5,0 N.m	Clamping screw
25	7808121	FS60620RB	5,0 N.m	Clamping screw
30 - 32	7808122	FS80624RB	6,0 N.m	Clamping screw
6	7808203	T6-D (Torx 6)	-	Wrench
8	7808204	T7-D (Torx 7)	-	Wrench
10	7808205	T8-D (Torx 8)	-	Wrench
12	7808207	T10-D (Torx 10)	-	Wrench
16	7808208	T15-D (Torx 15)	-	Wrench
20	7808209	T20-D (Torx 20)	-	Wrench
25	7808209	T20-D (Torx 20)	-	Wrench
30 - 32	7808212	T30-T (Torx 30)	-	Wrench



PFB SCREW FIT

Milling | Indexables

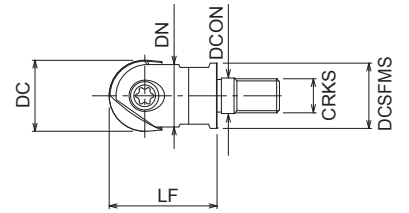

- Finishing ball nose cutter
- Excellent sharpness
- Screw fit type
- 10 - 30 mm

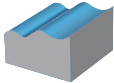

EDP	Designation	ZEFP	DC	RE	LF	DCON	DCSFMS	DN	Seat size	CRKS	Wrench size	Applicable Shank
7801490	PFB-R100SF6	2	10	6	26	6,5	9	9	3	6	7	①
7801491	PFB-R120SF6	2	12	8	26	6,5	11	11	4	6	7	②
7801492	PFB-R160SF8	2	16	10	32	8,5	14,5	14	5	8	10	③
7801493	PFB-R200SF10	2	20	12,5	38	10,5	18	18	6	10	14	④
7801494	PFB-R250SF12	2	25	15	38	12,5	23	22	7	12	17	⑤
7801495	PFB-R300SF16	2	30	-	43	17	28	27	8	16	22	⑥

Milling | Indexables



Accessories and spare parts

Applicable cutter DC	EDP	Designation	Torque	Specification
6	7808124	FS20652RB	0,8 N.m	Clamping screw
8	7808123	FS25669RB	1,0 N.m	Clamping screw
10	7808117	FS30686RB	1,2 N.m	Clamping screw
12	7808118	FS35610RB	2,0 N.m	Clamping screw
16	7808119	FS40613RB	3,0 N.m	Clamping screw
20	7808120	FS50615RB	5,0 N.m	Clamping screw
25	7808121	FS60620RB	5,0 N.m	Clamping screw
30 - 32	7808122	FS80624RB	6,0 N.m	Clamping screw
6	7808203	T6-D (Torx 6)	-	Wrench
8	7808204	T7-D (Torx 7)	-	Wrench
10	7808205	T8-D (Torx 8)	-	Wrench
12	7808207	T10-D (Torx 10)	-	Wrench
16	7808208	T15-D (Torx 15)	-	Wrench
20	7808209	T20-D (Torx 20)	-	Wrench
25	7808209	T20-D (Torx 20)	-	Wrench
30 - 32	7808212	T30-T (Torx 30)	-	Wrench

OP-SFA

Milling | Indexable

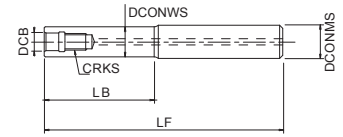
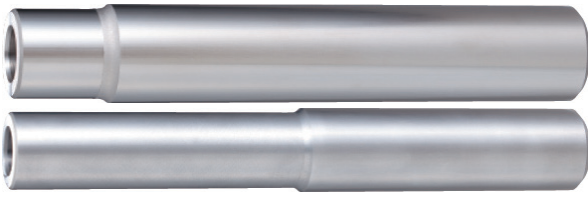

- Arbor for Screw fit type

	EDP	Designation	LF	LB	DCON	DCONWS	DCB	CRKS	Specification
①	7801904	SF-M06SS10-4	104	4	10	9	6,5	6	Steel
②	7801905	SF-M06SS12-10	104	10	12	11	6,5	6	Steel
③	7801900	SF-M08SS16-15	95	15	16	14,5	8,5	8	Steel
④	7801901	SF-M10SS20-20	120	20	20	18	10,5	10	Steel
⑤	7801902	SF-M12SS25-35	135	35	25	23	12,5	12	Steel
⑥	7801903	SF-M16SS32-35	155	35	32	28	17	16	Steel
①	7801918	SF-M06SS10-24CS	124	24	10	9	6,5	6	Carbide
②	7801919	SF-M06SS12-34CS	134	34	12	11	6,5	6	Carbide
③	7801910	SF-M08SS16-55CS	115	55	16	14,5	8,5	8	Carbide
③	7801911	SF-M08SS16-85CS	145	85	16	14,5	8,5	8	Carbide
④	7801912	SF-M10SS20-70CS	140	70	20	18	10,5	10	Carbide
④	7801913	SF-M10SS20-110CS	180	110	20	18	10,5	10	Carbide
⑤	7801914	SF-M12SS25-90CS	170	90	25	23	12,5	12	Carbide
⑤	7801915	SF-M12SS25-140CS	220	140	25	23	12,5	12	Carbide
⑥	7801916	SF-M16SS32-120CS	220	120	32	28	17	16	Carbide
⑥	7801917	SF-M16SS32-190CS	290	190	32	28	17	16	Carbide



PFB INSERTS NEW SIZES

Milling | Indexables

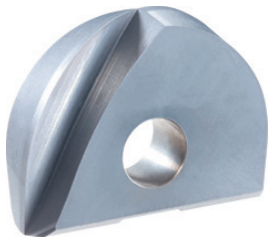

- Finishing ball nose cutter
- Excellent sharpness
- 6 - 32 mm

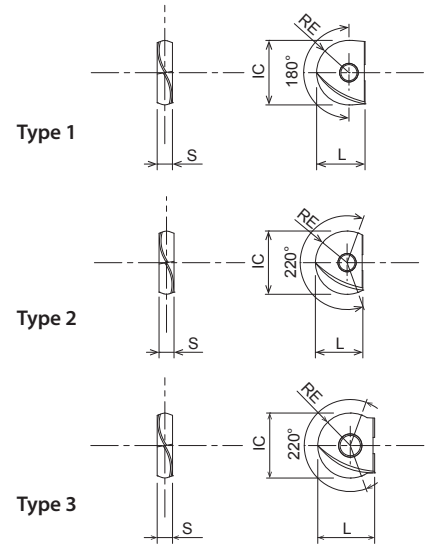

EDP	Designation	Range de-gree	IC	S	L	RE	Type	Grade	Body size	P		M		K		N		S		H		
										dry	⊖	dry	⊖	GG	GGG	dry	⊖	dry	⊖	dry	⊖	
7820030	PFB080-SP	180	8	2,4	7	4	1	XP3225	2	●		●										
7820031	PFB100-SP	180	10	2,6	8,5	5	1	XP3225	3	●		●										
7820032	PFB120-SP	180	12	3	10	6	1	XP3225	4	●		●										
7820033	PFB160-SP	180	16	4	12	8	1	XP3225	5	●		●										
7820034	PFB200-SP	180	20	5	15	10	1	XP3225	6	●		●										
7820035	PFB250-SP	180	25	6	18,5	12,5	1	XP3225	7	●		●										
7820036	PFB300-SP	180	30	7	22,5	15	1	XP3225	8	●		●										
7820010	PFB080-SP	180	8	2,4	7	4	1	XP3320	2	○		○		○	○				○		○	
7820011	PFB100-SP	180	10	2,6	8,5	5	1	XP3320	3	○		○		○	○				○		○	
7820012	PFB120-SP	180	12	3	10	6	1	XP3320	4	○		○		○	○				○		○	
7820013	PFB160-SP	180	16	4	12	8	1	XP3320	5	○		○		○	○				○		○	
7820014	PFB200-SP	180	20	5	15	10	1	XP3320	6	○		○		○	○				○		○	
7820015	PFB250-SP	180	25	6	18,5	12,5	1	XP3320	7	○		○		○	○				○		○	
7820016	PFB300-SP	180	30	7	22,5	15	1	XP3320	8	○		○		○	○				○		○	
7820039	PFB060-SH	220	6	2	5	3	2	XP3310	1					●	●						●	●
7820040	PFB080-SH	180	8	2,4	7	4	1	XP3310	2					●	●						●	●
7820041	PFB100-SH	180	10	2,6	8,5	5	1	XP3310	3					●	●						●	●
7820042	PFB120-SH	180	12	3	10	6	1	XP3310	4					●	●						●	●
7820043	PFB160-SH	180	16	4	12	8	1	XP3310	5					●	●						●	●
7820044	PFB200-SH	180	20	5	15	10	1	XP3310	6					●	●						●	●
7820045	PFB250-SH	180	25	6	18,5	12,5	1	XP3310	7					●	●						●	●
7820046	PFB300-SH	180	30	7	22,5	15	1	XP3310	8					●	●						●	●
7820047	PFB320-SH	180	32	7	23,5	16	1	XP3310	9					●	●						●	●
48333000	PFB160-Q-SH	220	16	4	12	8	2	XP3310	5					●	●						●	●
48333001	PFB200-Q-SH	220	20	5	15	10	2	XP3310	6					●	●						●	●
7820107	PFB100-HH NEW	180	10	2,6	8,5	5	1	XP6703	3	○				○	○						○	○
7820108	PFB120-HH NEW	180	12	3	10	6	1	XP6703	4	○				○	○						○	○
7820109	PFB160-HH NEW	180	16	4	12	8	1	XP6703	5	○				○	○						○	○
7820110	PFB200-HH NEW	180	20	5	15	10	1	XP6703	6	○				○	○						○	○
7820111	PFB250-HH NEW	180	25	6	18,5	12,5	1	XP6703	7	○				○	○						○	○
7820112	PFB300-HH NEW	180	30	7	22,5	15	1	XP6703	8	○				○	○						○	○
7820113	PFB320-HH NEW	180	32	7	23,5	16	1	XP6703	9	○				○	○						○	○
7820018	PFB060-D	220	6	2	5	3	2	XC4505	1								●					
7820019	PFB070-D	220	7	2	5,5	3,5	2	XC4505	1								●					
7820020	PFB080-D	180	8	2,4	7	4	1	XC4505	2								●					
7820021	PFB100-D	180	10	2,6	8,5	5	1	XC4505	3								●					
7820022	PFB120-D	180	12	3	10	6	1	XC4505	4								●					
7820023	PFB160-D	180	16	4	12	8	1	XC4505	5								●					
7820024	PFB200-D	180	20	5	15	10	1	XC4505	6								●					
7820025	PFB250-D	180	25	6	18,5	12,5	1	XC4505	7								●					
7820026	PFB300-D	180	30	7	22,5	15	1	XC4505	8								●					
7820048	PFB060-Q	220	6	2	5	3	2	XP3225	1	●		●								○		
7820049	PFB070-Q	220	7	2	5,5	3,5	2	XP3225	1	●		●								○		
7820050	PFB080-Q	220	8	2,4	7	4	2	XP3225	2	●		●								○		
7820051	PFB100-Q	220	10	2,6	8,5	5	2	XP3225	3	●		●								○		
7820052	PFB120-Q	220	12	3	10	6	2	XP3225	4	●		●								○		
7820053	PFB160-Q	220	16	4	12	8	3	XP3225	5	●		●								○		
7820054	PFB200-Q	220	20	5	15	10	3	XP3225	6	●		●								○		
7820055	PFB250-Q	220	25	6	18,5	12,5	3	XP3225	7	●		●								○		
7820056	PFB300-Q	220	30	7	22,5	15	3	XP3225	8	●		●								○		
7820060	PFB080-Q-ST	200	8	2,4	7	4	2	XP2225	2	○		○									○	○
7820061	PFB100-Q-ST	200	10	2,6	8,5	5	2	XP2225	3	○		○									○	○
7820062	PFB120-Q-ST	200	12	3	10	6	2	XP2225	4	○		○									○	○
7820063	PFB160-Q-ST	220	16	4	12	8	3	XP2225	5	○		○									○	○
7820064	PFB200-Q-ST	220	20	5	15	10	3	XP2225	6	○		○									○	○
7820065	PFB250-Q-ST	220	25	6	18,5	12,5	3	XP2225	7	○		○									○	○
7820066	PFB300-Q-ST	220	30	7	22,5	15	3	XP2225	8	○		○									○	○

Milling | Indexables
Inserts



CUTTING CONDITIONS

Milling | Indexables | Cutting conditions

PFB-SP, PFB-Q, PFB-SH, PFB-Q-ST, PFB-HH

Finishing ball nose cutter

	Work Material	Tensile Strength / Hardness	Milling Speed Vc (m/min)	Depth of Cut ap (mm)	Feed per Tooth fz (mm/t)			
					D			
					Ø 6,8	Ø 10,12	Ø 16,20	Ø 25-30-32
P	Mild Steel-Carbon Steel (S5400-S10C)	~180HB	300 (200~ 400)	0,02 D	0,1	0,12	0,14	0,18
	Carbon Steel-Alloy Steel (S50C-SCM440)	~280HB	300 (200~ 400)	0,02 D	0,07	0,1	0,12	0,14
	Die Steel (SKD11-SKD61)	~280HB	250 (150 ~ 350)	0,02 D	0,07	0,1	0,12	0,14
M	Stainless Steel (Dry) (SUS304-SUS420)	~250HB	250 (150 ~ 350)	0,02 D	0,07	0,12	0,14	0,17
K	Cast Iron (FC250)	~300N/mm ²	400 (300~ 500)	0,02 D	0,12	0,14	0,18	0,22
	Ductile Cast Iron (FCD400)	~600N/mm ²	300 (200~ 400)	0,02 D	0,1	0,12	0,14	0,18
N	Aluminium Alloy	~13% Si	500 (400~ 600)	0,03 D	0,12	0,14	0,18	0,22
	Copper Alloy (C1100)	-	300 (200 ~ 400)	0,03 D	0,11	0,13	0,17	0,22
S	Heat Resistant Alloys (Wet) (Inconel 718)	-	50 (25~ 80)	0,015 D	0,04	0,05	0,06	0,06
	Titanium Alloy (Wet) (Ti-Al-4V)	-	90 (40~120)	0,02 D	0,06	0,08	0,11	0,13
H	Pre-hardened Steel (NAK80, STAVAX)	40~43HRC	200 (100~ 300)	0,015 D	0,06	0,07	0,08	0,1
	Steel for Die Casting (DAC55-DH31)	43~48HRC	180 (90 ~ 200)	0,015 D	0,05	0,06	0,07	0,07
	Hardened Steel (SKD11)	50~60HRC	150 (100 ~ 250)	0,01 D	0,05	0,06	0,07	0,07

PFB-D

Finishing ball nose cutter

	Work Material	Tensile Strength / Hardness	Milling Speed Vc (m/min)	Depth of Cut ap (mm)	Feed per Tooth fz (mm/t)			
					D			
					Ø 6,8	Ø 10,12	Ø 16,20	Ø 25-30-32
N	Graphite	-	500 (400~ 600)	0,03 D	0,14	0,17	0,21	0,25
	CFRP Carbon Fiber Reinforced Plastic	-	300 (300 ~ 500)	0,03 D	0,11	0,13	0,17	0,20



CUTTING CONDITIONS

Milling | Indexables | Cutting conditions

PFB

Chart of cutting depth and actual cutting diameter

Depth of cut		Actual cutting diameter														
D	R	0,1	0,2	0,3	0,4	0,5	0,8	1	1,5	2	2,5	3	3,5	4	4,5	5
6	3	1,5	2,2	2,6	3	3,3	4,1	-	-	-	-	-	-	-	-	-
7	3,5	1,6	2,3	2,8	3,3	3,6	4,5	-	-	-	-	-	-	-	-	-
8	4	1,8	2,5	3	3,5	3,9	4,8	-	-	-	-	-	-	-	-	-
10	5	2	2,8	3,4	3,9	4,4	5,4	6	7,1	-	-	-	-	-	-	-
12	6	2,2	3,1	3,7	4,3	4,8	6	6,6	7,9	8,9	-	-	-	-	-	-
16	8	2,5	3,6	4,3	5	5,6	7	7,7	9,3	10,6	11,6	-	-	-	-	-
20	10	2,8	4	4,9	5,6	6,2	7,8	8,7	10,5	12	13,2	14,3	15,2	-	-	-
25	12,5	3,2	4,5	5,4	6,3	7	8,8	9,8	11,9	13,6	15	16,2	17,3	18,3	-	-
30	15	3,5	4,9	6	6,9	7,7	9,7	10,8	13,1	15	16,6	18	19,3	20,4	21,4	22,4
32	16	3,6	5	6,2	7,1	7,9	10	11,1	13,5	15,5	17,2	18,7	20	21,2	22,2	23,2

How to determine actual cutting diameter D

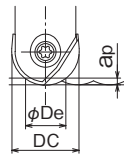

$$D = 2 \sqrt{ap \times (Dc - ap)}$$

Recommended pick feed and milling surface roughness

Unit: mm

D	6	7	8	10	12	16	20	25	30	32
Pf	0,4	0,45	0,5	0,6	0,7	0,8	1	1,2	1,3	1,4
h	0,007	0,007	0,008	0,009	0,01	0,01	0,012	0,014	0,014	0,015

Theoretical milling surface roughness

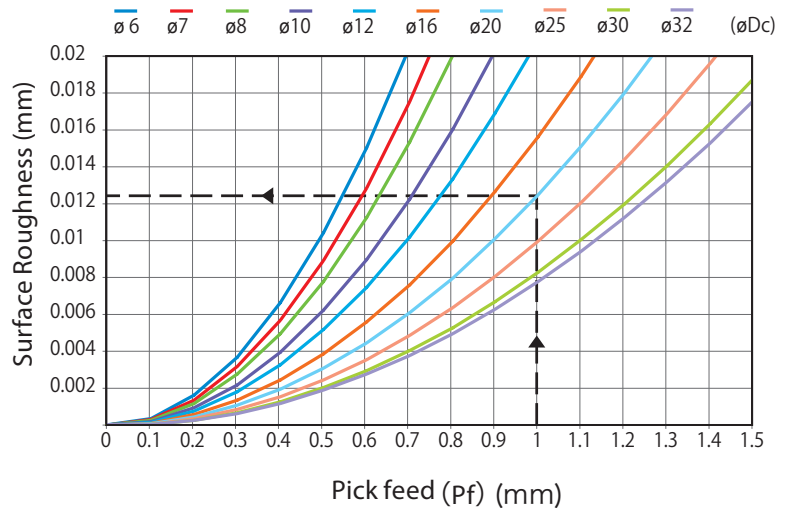
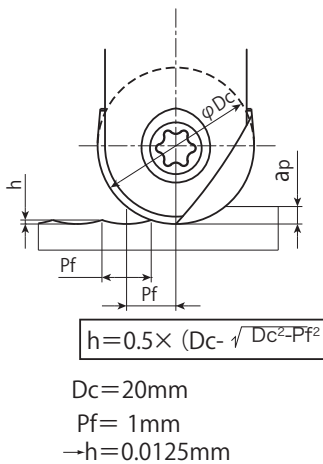

CUTTING CONDITIONS

Milling | Indexables | Cutting conditions

PFB

Finish Ball nose cutter

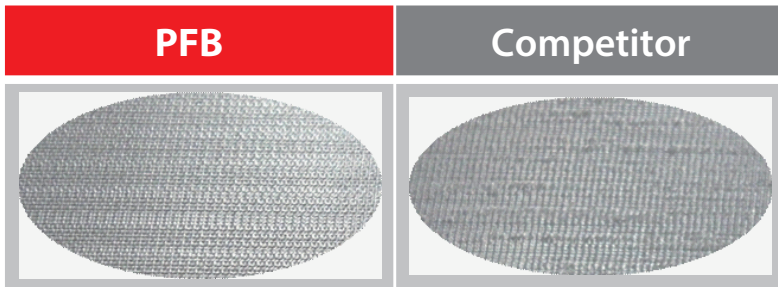

Machining Detail		Machining Parameters	
Size	R10	Name of Part	Sample model
Overhang	80mm	Material	S50C
Speed	8,000min ⁻¹	Machining Method	Copy Milling
Feed	3,200mm/min	Machining Type	Horizontal Machine
ap	0.3mm	Holder Size	BT50
Pf	0.3mm	Coolant Size	Water Soluble

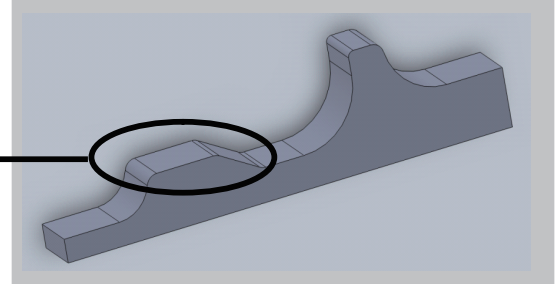

Machining Method	Product	2	4	6	8	10 (µm)	RZ (µm)
Copy Milling Flat Surface	PFB	[Bar chart showing RZ values for PFB on flat surface]					6,171
	A	[Bar chart showing RZ values for Product A on flat surface]					10,93
	B	[Bar chart showing RZ values for Product B on flat surface]					6,021
	C	[Bar chart showing RZ values for Product C on flat surface]					7,798
	D	[Bar chart showing RZ values for Product D on flat surface]					6,963
Machining Method	Product	0.5	1	1.5	2	2.5 (µm)	RZ (µm)
Copy Milling Slanted Surface	PFB	[Bar chart showing RZ values for PFB on slanted surface]					1,967
	A	[Bar chart showing RZ values for Product A on slanted surface]					2,098
	B	[Bar chart showing RZ values for Product B on slanted surface]					2,083
	C	[Bar chart showing RZ values for Product C on slanted surface]					2,541
	D	[Bar chart showing RZ values for Product D on slanted surface]					1,827
Machining Method	Product	0.5	1	1.5	2	2.5 (µm)	RZ (µm)
Copy Milling Radial Surface	PFB	[Bar chart showing RZ values for PFB on radial surface]					1,98
	A	[Bar chart showing RZ values for Product A on radial surface]					1,9
	B	[Bar chart showing RZ values for Product B on radial surface]					2,183
	C	[Bar chart showing RZ values for Product C on radial surface]					2
	D	[Bar chart showing RZ values for Product D on radial surface]					2,508

Comparison of tool wear - PFB

Machining Detail		Machining Parameters	
Size	R10	Name of Part	Blade
Overhang	110mm	Material	SUH600
Speed	1,500min ⁻¹	Machining Method	Copy Milling
Feed	2,000mm/min	Machining Type	Vertical Machining Center
ap	0.2mm	Holder Size	BT40
Pf	1mm	Coolant Size	Water Soluble

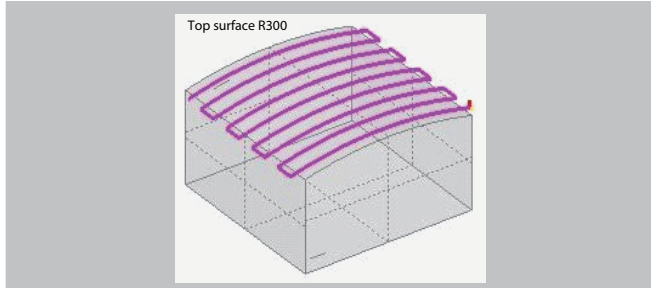

Machined Time	70 minutes		140 minutes	
Machined Length	100m		200m	
PFB	[Microscopic image of PFB tool wear at 70m]		[Microscopic image of PFB tool wear at 140m]	
	Wear (mm)	0.033	0.030	0.041
Competitor	[Microscopic image of Competitor tool wear at 70m]		[Microscopic image of Competitor tool wear at 140m]	
	Wear (mm)	0.032	0.033	0.070

Comparison of tool wear after 200M of machining



FEATURES: PHOENIX PFR

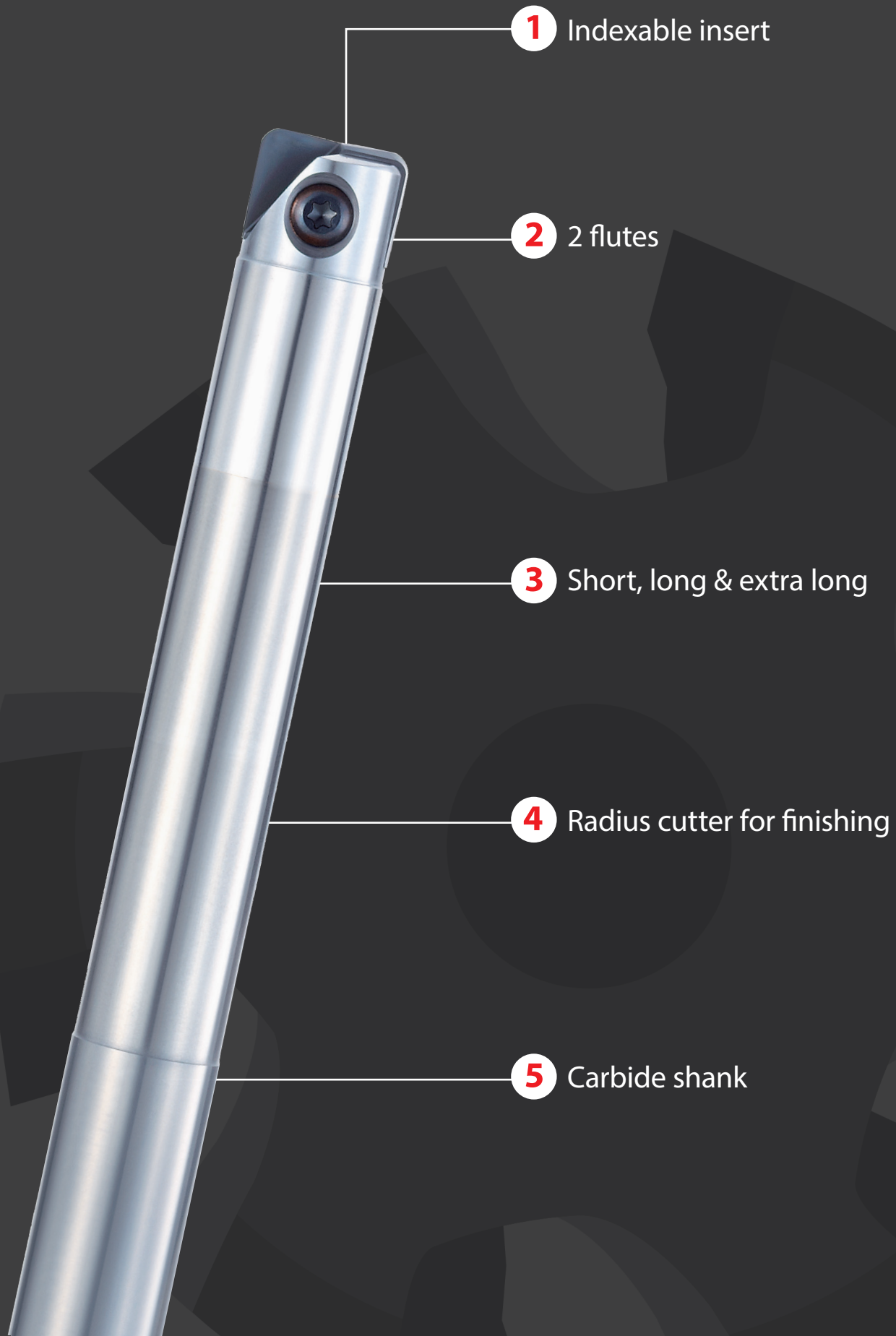

PFR INSERTS

Milling | Indexables

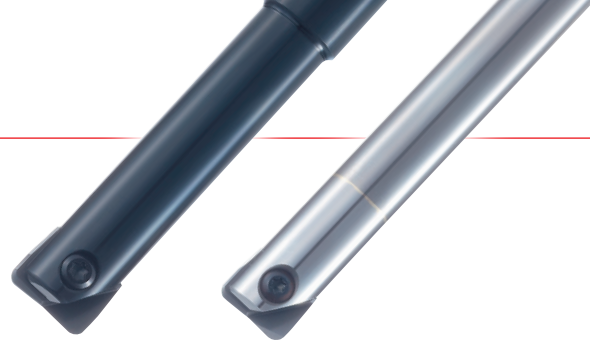

Beautifully finished surfaces

With the advanced grinding technology, PFR inserts have high dimensional accuracy and flat drag on the end cutting edge. It enables outstanding machining precision and finished surface.

- $\pm 8\mu\text{m}$ Corner radius precision: $\pm 8\mu\text{m}$
- $0\sim-0,020\text{mm}$ Tolerance for outer diameter : -0.020 mm

Finished surface roughness curve

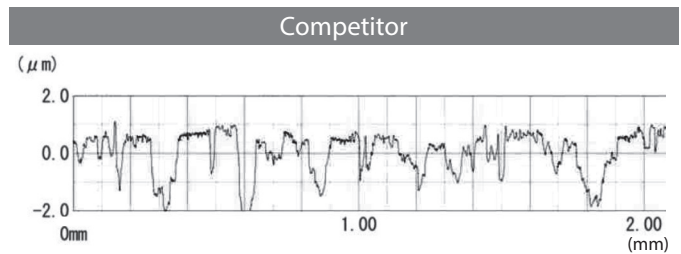
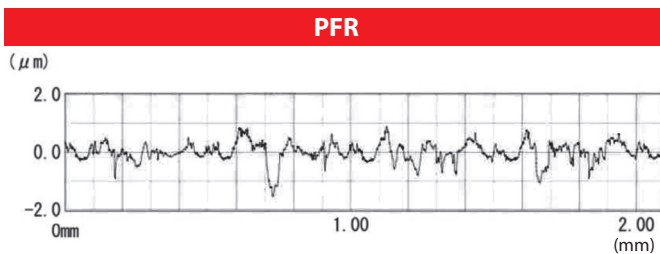

Three types of insert are available. All inserts are specially processed

PFR-ST

- Applicable to a wide variety of work materials from mild steel to hardened steel
- Ideal for milling with long overhangs ($L/D \geq 5$)
- Positive rake angle with excellent sharpness and bite

XP3225 Grade

- For stable milling of a wide variety of work materials
- Excellent lubricity and wear resistance

PFR-SH

- For milling cast iron, ductile iron and hardened steel
- High rigid cutting edge with two-dimensional negative chamfer, which is applicable to unstable machining conditions
- Highly resistant carbide material

XP3310 Grade

- Ideal for dry milling of high hardened steel and cast iron
- Excellent heat resistance and wear resistance

PFR-D

- Sharp cutting edge specialized for milling graphite
- Highly adhesive carbide material for diamond coating

XC4505 Grade

- For milling nonferrous material
- Optimal diamond coating for milling graphite



PROCESSING DATA

Milling | Indexables

PX5 (33HRC) Side and Bottom finish for PX5 (pre-hardened steel)

Tool	PFR-R250S25-LL260CS
Insert (grade)	PFR250R20-ST (XP3225)
Work Material	PX5 (33HRC)
Cutting Speed	82m/min(1,050min ⁻¹)
Feed	500mm/min(0.24mm/t)
Depth of Cut	$a_p=0.5\text{mm}$ $a_e=0.5\sim 1\text{mm}$
Coolant	Water Soluble
Machine	Horizontal Machining Center (BT50)

PFR enabled high precision machining as well as solid carbide tool. With the sharper cutting edge than conventional tools, PFR could be operated stably with deeper depth of cut. As a result, machining time was shortened by reducing semi-finishing process.

Examples from users Machined workpiece: die insert

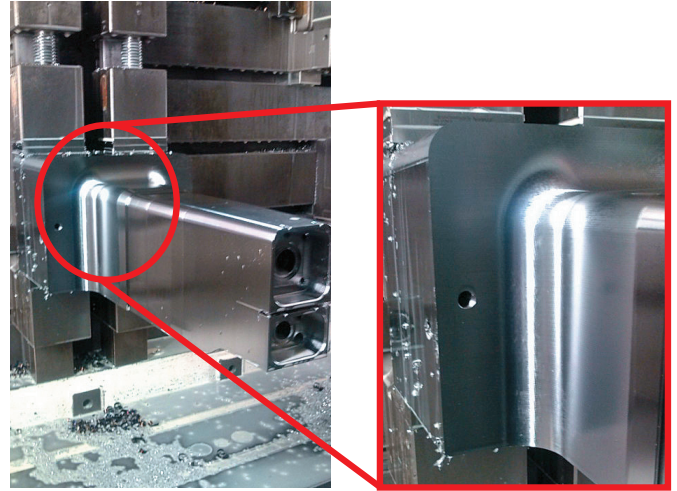

State of damage to blade edge after 88 m (three hours) of machining on a workpiece



● Rake

● Flank

Side and Bottom finish for plastic mold steel

Tool	PFB-R200S20-LL240CS	
Insert (grade)	PFR200R10-ST (XP3225)	
Work Material	SD18 (JIS S55C)	
Cutting Speed	Side finish section 330m/min(5.250min ⁻¹)	Bottom finish section 100m/min(1.600min ⁻¹)
Feed	2,100mm/min(0,2mm/t)	400mm/min(0,125mm/t)
Depth of Cut	$a_p=1,5\text{mm}$ $a_e=0,05\sim 0,3\text{mm}$	$a_p=0,15\text{mm}$ Semi-finish $a_p=0,05\text{mm}$ Final finish
Coolant	Air Blow	
Machine	Vertical Machining Center (HSK A100)	

With the conventional tool, one insert for semi-finishing and another insert for finishing were consumed. With PFR, one insert could be last until the final finishing process. Furthermore, better finished surface was achieved.

Examples from users

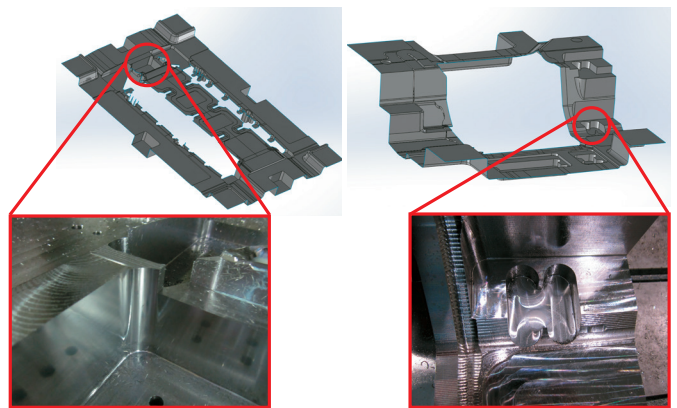

State of damage after total machining process (90 min)

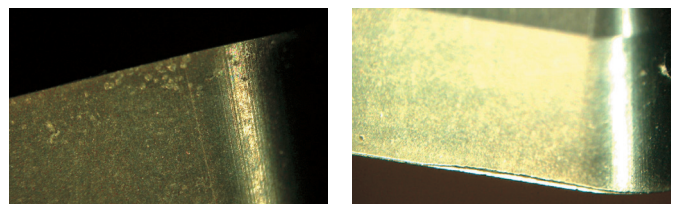

The tip shows normal wear, and there is no chipping despite the long overhang length.

PROCESSING DATA

Milling | Indexables

FCD600 Durability performance evaluation

Tool	PFR-R200SS20-S160
Insert (grade)	PFR200R10-SH (XP3310)
Work Material	FCD600
Cutting Speed	200m/min(3.200min ⁻¹)
Feed	1.280mm/min(0,2mm/t)
Depth of Cut	a _p =1mm a _e =2mm
Coolant	Air Blow
Machine	Horizontal Machining Center (BT40)

PFR enabled stable machining, and the wear progress had been slow since the early stage.

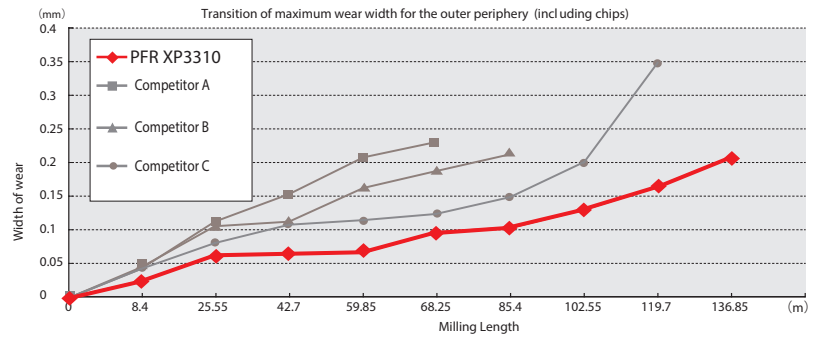

DH31(48HRC) Durability performance evaluation

Tool	PFR-R200SS20-S160
Insert (grade)	PFR200R10-SH (XP3310)
Work Material	DH31(48HRC)
Cutting Speed	60m/min(955min ⁻¹)
Feed	191mm/min(0.1mm/t)
Depth of Cut	a _p =0.5mm a _e =1mm
Coolant	Water Soluble
Machine	Horizontal Machining Center (BT40)

With the special chamfer on the cutting edge, PFR's insert XP3310 have a high chipping resistance. It enabled stable operation in machining hot work tool steel.

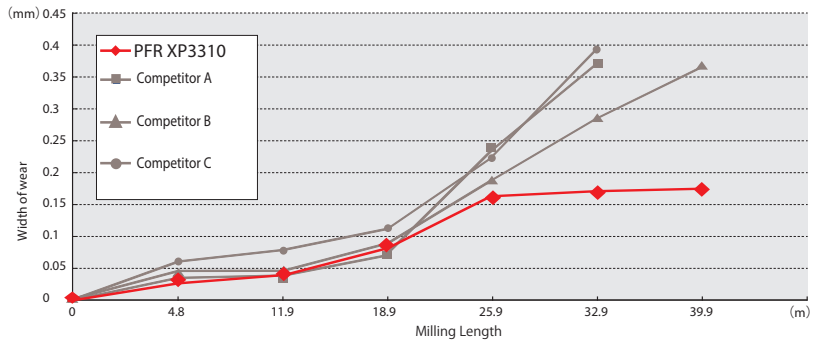

State of damage after 32.9 m of machining

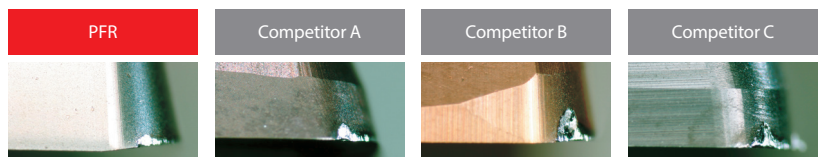

S50C Durability performance evaluation

Tool	PFR-R200SS20-S160
Insert (grade)	PFR200R10-ST (XP3225)
Work Material	S50C
Cutting Speed	200m/min(3,200min ⁻¹)
Feed	1,280mm/min(0.2mm/t)
Depth of Cut	a _p =0.1mma _e =2mm
Coolant	Water Soluble
Machine	Horizontal Machining Center (BT40)

Competitor products showed significant wear when exceeding 43m of milling length. PFR's insert XP3225, however, showed only little wear even after 140m length and remained good.

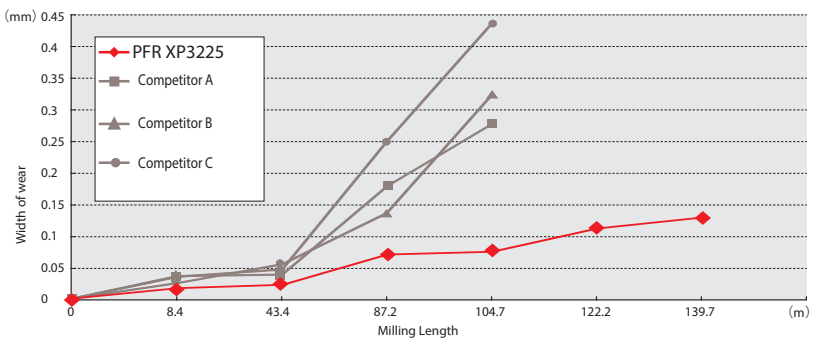

State of damage after 104.7 m of machining

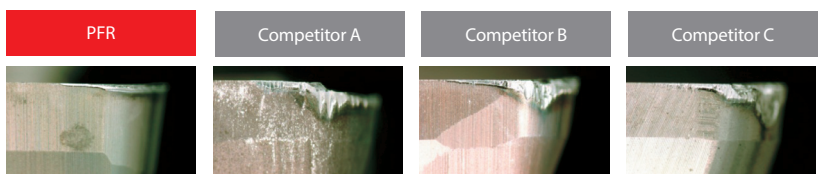

PROCESSING DATA

Milling | Indexables

PFR-D Field data of machining graphite electrode

Tool	PFR-R200SS20-S160CS
Insert (grade)	PFR200R20-D (XC4505)
Work Material	Graphite
Cutting Speed	125m/min(2.000min ⁻¹)
Feed	1.000mm/min(0,25mm/t)
Milling Method	Contour Milling
Depth of Cut	$a_p=1\text{mm}$ $a_e=0,5\text{mm}$
Coolant	None
Machine	Vertical Graphite Milling Machine (BT40)

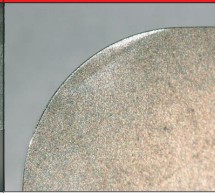
	Peripheral Cutting Edge	End Teeth	Rake angle
State of damage after 17 hours of machining			
(mm) Frank wear	0,049	0,021	

PFR-D achieved fair finishing surface accuracy versus the competition.
Also machining cost was reduced by applying PFB instead of using solid carbide end mills.

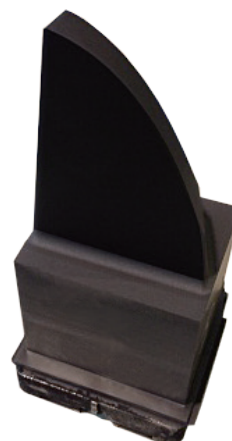

PFR-D Field data of machining die cast mold

Tool	PFR-R160SS-S140CS
Insert (grade)	PFR160R10-D (XC4505)
Work Material	Graphite
Overhang Length	50mm (2,5D)
Cutting Speed	135m/min(2,700min ⁻¹)
Feed	3.330mm/min(0.62mm/t)
Milling Method	Contour Milling
Depth of Cut	$a_p=0,22\sim 0,5\text{mm}$ $a_e=2\sim 8\text{mm}$
Coolant	None
Machine	Vertical Machining center (BT40)

	Peripheral Cutting Edge	End Teeth	Rake angle
State of damage after 10 hours of machining			
(mm) Frank wear	0,062	0,087	

After finish machining of 10 hours, cutting edge was in good shape with normal wear. No abnormal peel off of coating was found. By applying PFR-D, machining time was drastically reduced versus the competitor's diamond coated ball end mill.

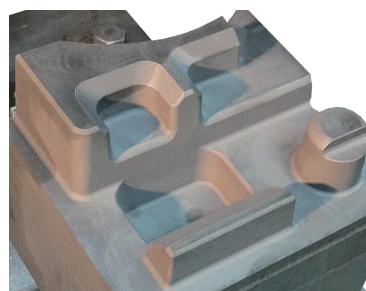

Shape of Test Piece

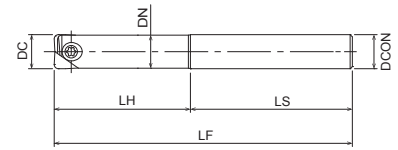

- Finishing corner radius cutter
- Excellent sharpness
- Cylindrical type
- 6 - 32 mm



EDP	Designation	ZEFP	DC	LF	LH	DCON	DN	LS	ULDR	Seat size	Specification
7832029	PFR-R060SS06-S80CS	2	6	80	15	6	5,4	65	2,5	1	Carbide
7832039	PFR-R060SS06-L100CS	2	6	100	30	6	5,4	70	5	1	Carbide
7832019	PFR-R060SS06-LL120CS	2	6	120	42	6	5,4	79	7	1	Carbide
7832030	PFR-R080SS08-S100CS	2	8	100	20	8	7,5	80	2,5	2	Carbide
7832040	PFR-R080SS08-L120CS	2	8	120	40	8	7,5	80	5	2	Carbide
7832020	PFR-R080SS08-LL140CS	2	8	140	56	8	7,5	84	7	2	Carbide
7832031	PFR-R100SS10-S100CS	2	10	100	25	10	9,5	75	2,5	3	Carbide
7832041	PFR-R100SS10-L130CS	2	10	130	50	10	9,5	80	5	3	Carbide
7832021	PFR-R100SS10-LL150CS	2	10	150	70	10	9,5	80	7	3	Carbide
7832032	PFR-R120SS12-S110CS	2	12	110	30	12	11,5	80	2,5	4	Carbide
7832042	PFR-R120SS12-L140CS	2	12	140	60	12	11,5	80	5	4	Carbide
7832022	PFR-R120SS12-LL160CS	2	12	160	84	12	11,5	76	7	4	Carbide
7832033	PFR-R160SS16-S140CS	2	16	140	40	16	15,5	100	2,5	5	Carbide
7832043	PFR-R160SS16-L160CS	2	16	160	72	16	15,5	88	4,5	5	Carbide
7832023	PFR-R160SS16-LL200CS	2	16	200	96	16	15,5	104	6	5	Carbide
7832034	PFR-R200SS20-S160CS	2	20	160	50	20	19,5	110	2,5	6	Carbide
7832044	PFR-R200SS20-L180CS	2	20	180	90	20	19,5	90	4,5	6	Carbide
7832024	PFR-R200SS20-LL240CS	2	20	240	120	20	19,5	120	6	6	Carbide
7832035	PFR-R250SS25-S160CS	2	25	160	62,5	25	24,5	97,5	2,5	7	Carbide
7832045	PFR-R250SS25-L200CS	2	25	200	100	25	24,5	100	4	7	Carbide
7832025	PFR-R250SS25-LL260CS	2	25	260	137,5	25	24,5	122,5	5,5	7	Carbide
7832036	PFR-R300SS32-S170CS	2	30	170	75	32	29,5	95	2,5	8	Carbide
7832046	PFR-R300SS32-L220CS	2	30	220	120	32	29,5	100	4	8	Carbide
7832026	PFR-R300SS32-LL290CS	2	30	290	165	32	29,5	125	5,5	8	Carbide
7832037	PFR-R320SS32-S180CS	2	32	180	80	32	31,5	100	2,5	9	Carbide
7832047	PFR-R320SS32-L230CS	2	32	230	128	32	31,5	102	4	9	Carbide
7832027	PFR-R320SS32-LL300CS	2	32	300	176	32	31,5	124	5,5	9	Carbide
7832000	PFR-R080SS08-S120	2	8	120	36	8	7,5	84	4,5	2	Steel
7832001	PFR-R100SS10-S130	2	10	130	45	10	9,5	85	4,5	3	Steel
7832002	PFR-R120SS12-S130	2	12	130	54	12	11,5	76	4,5	4	Steel
7832003	PFR-R160SS16-S140	2	16	140	64	16	15,5	76	4	5	Steel
7832004	PFR-R200SS20-S160	2	20	160	80	20	19,5	80	4	6	Steel
7832005	PFR-R250SS25-S160	2	25	160	75	25	24,5	85	3	7	Steel
7832006	PFR-R300SS32-S170	2	30	170	90	32	29,5	80	3	8	Steel
7832007	PFR-R320SS32-S180	2	32	180	96	32	31,5	84	3	9	Steel

Accessories and spare parts

Applicable cutter DC	EDP	Designation	Torque	Specification
6	7808124	FS20652RB	0,8 N.m	Clamping screw
8	7808123	FS25669RB	1,0 N.m	Clamping screw
10	7808117	FS30686RB	1,2 N.m	Clamping screw
12	7808118	FS35610RB	2,0 N.m	Clamping screw
16	7808119	FS40613RB	3,0 N.m	Clamping screw
20	7808120	FS50615RB	5,0 N.m	Clamping screw
25	7808121	FS60620RB	5,0 N.m	Clamping screw
30 - 32	7808122	FS80624RB	6,0 N.m	Clamping screw
6	7808203	T6-D (Torx 6)	-	Wrench
8	7808204	T7-D (Torx 7)	-	Wrench
10	7808205	T8-D (Torx 8)	-	Wrench
12	7808207	T10-D (Torx 10)	-	Wrench
16	7808208	T15-D (Torx 15)	-	Wrench
20	7808209	T20-D (Torx 20)	-	Wrench
25	7808209	T20-D (Torx 20)	-	Wrench
30 - 32	7808212	T30-T (Torx 30)	-	Wrench



PFR SCREW FIT

Milling | Indexables

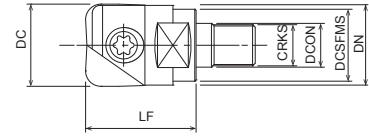

- Finishing corner radius cutter
- Excellent sharpness
- Screw fit type
- 10 - 32 mm



EDP	Designation	ZEFP	DC	LF	DCON	DCSFMS	DN	Seat size	CRKS	Wrench size	Applicable Shank
7832090	PFR-R100SF6	2	10	26	6,5	9	9	3	6	7	①
7832091	PFR-R120SF6	2	12	26	6,5	11	11	4	6	7	②
7832092	PFR-R160SF8	2	16	32	8,5	14,5	15	5	8	10	③
7832093	PFR-R200SF10	2	20	38	10,5	18	19	6	10	14	④
7832094	PFR-R250SF12	2	25	38	12,5	23	24	7	12	17	⑤
7832095	PFR-R300SF16	2	30	43	17	28	29	8	16	22	⑥
7832096	PFR-R320SF16	2	32	43	17	28	31	9	16	22	⑥

Milling | Indexables



Accessories and spare parts

Applicable cutter DC	EDP	Designation	Torque	Specification
6	7808124	FS20652RB	0,8 N.m	Clamping screw
8	7808123	FS25669RB	1,0 N.m	Clamping screw
10	7808117	FS30686RB	1,2 N.m	Clamping screw
12	7808118	FS35610RB	2,0 N.m	Clamping screw
16	7808119	FS40613RB	3,0 N.m	Clamping screw
20	7808120	FS50615RB	5,0 N.m	Clamping screw
25	7808121	FS60620RB	5,0 N.m	Clamping screw
30 - 32	7808122	FS80624RB	6,0 N.m	Clamping screw
6	7808203	T6-D (Torx 6)	-	Wrench
8	7808204	T7-D (Torx 7)	-	Wrench
10	7808205	T8-D (Torx 8)	-	Wrench
12	7808207	T10-D (Torx 10)	-	Wrench
16	7808208	T15-D (Torx 15)	-	Wrench
20	7808209	T20-D (Torx 20)	-	Wrench
25	7808209	T20-D (Torx 20)	-	Wrench
30 - 32	7808212	T30-T (Torx 30)	-	Wrench

OP-SFA

Milling | Indexable

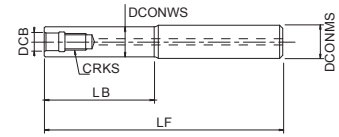
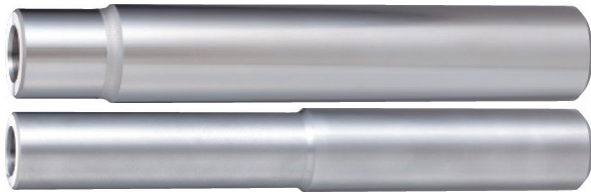

- Arbor for Screw fit type

	EDP	Designation	LF	LB	DCON	DCONWS	DCB	CRKS	Specification
①	7801904	SF-M06SS10-4	104	4	10	9	6,5	6	Steel
②	7801905	SF-M06SS12-10	104	10	12	11	6,5	6	Steel
③	7801900	SF-M08SS16-15	95	15	16	14,5	8,5	8	Steel
④	7801901	SF-M10SS20-20	120	20	20	18	10,5	10	Steel
⑤	7801902	SF-M12SS25-35	135	35	25	23	12,5	12	Steel
⑥	7801903	SF-M16SS32-35	155	35	32	28	17	16	Steel
①	7801918	SF-M06SS10-24CS	124	24	10	9	6,5	6	Carbide
②	7801919	SF-M06SS12-34CS	134	34	12	11	6,5	6	Carbide
③	7801910	SF-M08SS16-55CS	115	55	16	14,5	8,5	8	Carbide
③	7801911	SF-M08SS16-85CS	145	85	16	14,5	8,5	8	Carbide
④	7801912	SF-M10SS20-70CS	140	70	20	18	10,5	10	Carbide
④	7801913	SF-M10SS20-110CS	180	110	20	18	10,5	10	Carbide
⑤	7801914	SF-M12SS25-90CS	170	90	25	23	12,5	12	Carbide
⑤	7801915	SF-M12SS25-140CS	220	140	25	23	12,5	12	Carbide
⑥	7801916	SF-M16SS32-120CS	220	120	32	28	17	16	Carbide
⑥	7801917	SF-M16SS32-190CS	290	190	32	28	17	16	Carbide



PFR INSERTS

Milling | Indexables

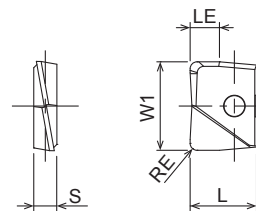
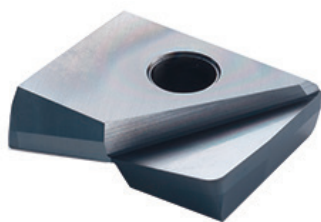

- Finishing corner radius cutter
- Excellent sharpness
- 6 - 32 mm

EDP	Designation	S	W1	L	RE	LE	Grade	Body size	P		M		K		N		S		H		
									dry	⊿	dry	⊿	GG	GGG	dry	⊿	dry	⊿	dry	⊿	
7820350	PFR060R03-ST	2	6	5	0,3	2	XP3225	1	●		●		○	○	●			●	○		
7820351	PFR060R05-ST	2	6	5	0,5	2	XP3225	1	●		●		○	○	●			●	○		
7820352	PFR060R10-ST	2	6	5	1	2	XP3225	1	●		●		○	○	●			●	○		
7820353	PFR070R03-ST	2	7	5,5	0,3	2	XP3225	1	●		●		○	○	●			●	○		
7820354	PFR070R05-ST	2	7	5,5	0,5	2	XP3225	1	●		●		○	○	●			●	○		
7820355	PFR070R10-ST	2	7	5,5	1	2	XP3225	1	●		●		○	○	●			●	○		
7820200	PFR080R03-ST	2,4	8	7	0,3	2,7	XP3225	2	●		●		○	○	●			●	○		
7820201	PFR080R05-ST	2,4	8	7	0,5	2,7	XP3225	2	●		●		○	○	●			●	○		
7820202	PFR080R10-ST	2,4	8	7	1	2,7	XP3225	2	●		●		○	○	●			●	○		
7820203	PFR080R20-ST	2,4	8	7	2	2,7	XP3225	2	●		●		○	○	●			●	○		
7820204	PFR100R03-ST	2,6	10	8,5	0,3	3,3	XP3225	3	●		●		○	○	●			●	○		
7820205	PFR100R05-ST	2,6	10	8,5	0,5	3,3	XP3225	3	●		●		○	○	●			●	○		
7820206	PFR100R10-ST	2,6	10	8,5	1	3,3	XP3225	3	●		●		○	○	●			●	○		
7820207	PFR100R20-ST	2,6	10	8,5	2	3,3	XP3225	3	●		●		○	○	●			●	○		
7820356	PFR110R03-ST	2,6	11	8,5	0,3	3,3	XP3225	3	●		●		○	○	●			●	○		
7820357	PFR110R05-ST	2,6	11	8,5	0,5	3,3	XP3225	3	●		●		○	○	●			●	○		
7820358	PFR110R10-ST	2,6	11	8,5	1	3,3	XP3225	3	●		●		○	○	●			●	○		
7820359	PFR110R20-ST	2,6	11	8,5	2	3,3	XP3225	3	●		●		○	○	●			●	○		
7820208	PFR120R03-ST	3	12	10	0,3	4	XP3225	4	●		●		○	○	●			●	○		
7820209	PFR120R05-ST	3	12	10	0,5	4	XP3225	4	●		●		○	○	●			●	○		
7820210	PFR120R10-ST	3	12	10	1	4	XP3225	4	●		●		○	○	●			●	○		
7820211	PFR120R20-ST	3	12	10	2	4	XP3225	4	●		●		○	○	●			●	○		
7820212	PFR120R30-ST	3	12	10	3	4	XP3225	4	●		●		○	○	●			●	○		
7820360	PFR130R03-ST	3	13	10	0,3	4	XP3225	4	●		●		○	○	●			●	○		
7820361	PFR130R05-ST	3	13	10	0,5	4	XP3225	4	●		●		○	○	●			●	○		
7820362	PFR130R10-ST	3	13	10	1	4	XP3225	4	●		●		○	○	●			●	○		
7820363	PFR130R20-ST	3	13	10	2	4	XP3225	4	●		●		○	○	●			●	○		
7820213	PFR160R03-ST	4	16	12	0,3	5,3	XP3225	5	●		●		○	○	●			●	○		
7820214	PFR160R05-ST	4	16	12	0,5	5,3	XP3225	5	●		●		○	○	●			●	○		
7820215	PFR160R10-ST	4	16	12	1	5,3	XP3225	5	●		●		○	○	●			●	○		
7820216	PFR160R20-ST	4	16	12	2	5,3	XP3225	5	●		●		○	○	●			●	○		
7820217	PFR160R30-ST	4	16	12	3	5,3	XP3225	5	●		●		○	○	●			●	○		
7820364	PFR170R03-ST	4	17	12	0,3	5,3	XP3225	5	●		●		○	○	●			●	○		
7820365	PFR170R05-ST	4	17	12	0,5	5,3	XP3225	5	●		●		○	○	●			●	○		
7820366	PFR170R10-ST	4	17	12	1	5,3	XP3225	5	●		●		○	○	●			●	○		
7820367	PFR170R20-ST	4	17	12	2	5,3	XP3225	5	●		●		○	○	●			●	○		
7820218	PFR200R03-ST	5	20	15	0,3	6,7	XP3225	6	●		●		○	○	●			●	○		
7820219	PFR200R05-ST	5	20	15	0,5	6,7	XP3225	6	●		●		○	○	●			●	○		
7820220	PFR200R10-ST	5	20	15	1	6,7	XP3225	6	●		●		○	○	●			●	○		
7820221	PFR200R20-ST	5	20	15	2	6,7	XP3225	6	●		●		○	○	●			●	○		
7820222	PFR200R30-ST	5	20	15	3	6,7	XP3225	6	●		●		○	○	●			●	○		
7820368	PFR210R03-ST	5	21	15	0,3	6,7	XP3225	6	●		●		○	○	●			●	○		
7820369	PFR210R05-ST	5	21	15	0,5	6,7	XP3225	6	●		●		○	○	●			●	○		
7820370	PFR210R10-ST	5	21	15	1	6,7	XP3225	6	●		●		○	○	●			●	○		
7820371	PFR210R20-ST	5	21	15	2	6,7	XP3225	6	●		●		○	○	●			●	○		
7820223	PFR250R03-ST	6	25	18,5	0,3	8,3	XP3225	7	●		●		○	○	●			●	○		
7820224	PFR250R05-ST	6	25	18,5	0,5	8,3	XP3225	7	●		●		○	○	●			●	○		
7820225	PFR250R10-ST	6	25	18,5	1	8,3	XP3225	7	●		●		○	○	●			●	○		
7820226	PFR250R20-ST	6	25	18,5	2	8,3	XP3225	7	●		●		○	○	●			●	○		
7820227	PFR250R30-ST	6	25	18,5	3	8,3	XP3225	7	●		●		○	○	●			●	○		
7820372	PFR260R03-ST	6	26	18,5	0,3	8,3	XP3225	7	●		●		○	○	●			●	○		
7820373	PFR260R05-ST	6	26	18,5	0,5	8,3	XP3225	7	●		●		○	○	●			●	○		
7820374	PFR260R10-ST	6	26	18,5	1	8,3	XP3225	7	●		●		○	○	●			●	○		

Milling | Indexables

Inserts

PFR INSERTS

Milling | Indexables

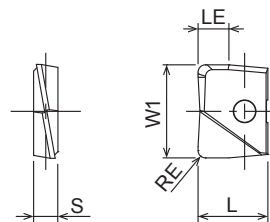
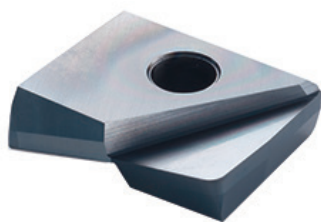

- Finishing corner radius cutter
- Excellent sharpness
- 6 - 32 mm

EDP	Designation	S	W1	L	RE	LE	Grade	Body size	P		M		K		N		S		H	
									dry	☹	dry	☹	GG	GGG	dry	☹	dry	☹	dry	☹
7820375	PFR260R20-ST	6	26	18,5	2	8,3	XP3225	7	☹		☹		☹	☹	☹			☹	☹	
7820228	PFR300R03-ST	7	30	22,5	0,3	10	XP3225	8	☹		☹		☹	☹	☹			☹	☹	
7820229	PFR300R05-ST	7	30	22,5	0,5	10	XP3225	8	☹		☹		☹	☹	☹			☹	☹	
7820230	PFR300R10-ST	7	30	22,5	1	10	XP3225	8	☹		☹		☹	☹	☹			☹	☹	
7820231	PFR300R20-ST	7	30	22,5	2	10	XP3225	8	☹		☹		☹	☹	☹			☹	☹	
7820232	PFR300R30-ST	7	30	22,5	3	10	XP3225	8	☹		☹		☹	☹	☹			☹	☹	
7820233	PFR320R03-ST	7	32	23,5	0,3	10,3	XP3225	9	☹		☹		☹	☹	☹			☹	☹	
7820234	PFR320R05-ST	7	32	23,5	0,5	10,3	XP3225	9	☹		☹		☹	☹	☹			☹	☹	
7820235	PFR320R10-ST	7	32	23,5	1	10,3	XP3225	9	☹		☹		☹	☹	☹			☹	☹	
7820236	PFR320R20-ST	7	32	23,5	2	10,3	XP3225	9	☹		☹		☹	☹	☹			☹	☹	
7820237	PFR320R30-ST	7	32	23,5	3	10,3	XP3225	9	☹		☹		☹	☹	☹			☹	☹	
7820400	PFR060R03-SH	2	6	5	0,3	2	XP3310	1	☹		☹		☹	☹			☹	☹		
7820401	PFR060R05-SH	2	6	5	0,5	2	XP3310	1	☹		☹		☹	☹			☹	☹		
7820402	PFR060R10-SH	2	6	5	1	2	XP3310	1	☹		☹		☹	☹			☹	☹		
7820403	PFR070R03-SH	2	7	5,5	0,3	2	XP3310	1	☹		☹		☹	☹			☹	☹		
7820404	PFR070R05-SH	2	7	5,5	0,5	2	XP3310	1	☹		☹		☹	☹			☹	☹		
7820405	PFR070R10-SH	2	7	5,5	1	2	XP3310	1	☹		☹		☹	☹			☹	☹		
7820250	PFR080R03-SH	2,4	8	7	0,3	2,7	XP3310	2	☹		☹		☹	☹			☹	☹		
7820251	PFR080R05-SH	2,4	8	7	0,5	2,7	XP3310	2	☹		☹		☹	☹			☹	☹		
7820252	PFR080R10-SH	2,4	8	7	1	2,7	XP3310	2	☹		☹		☹	☹			☹	☹		
7820253	PFR080R20-SH	2,4	8	7	2	2,7	XP3310	2	☹		☹		☹	☹			☹	☹		
7820254	PFR100R03-SH	2,6	10	8,5	0,3	3,3	XP3310	3	☹		☹		☹	☹			☹	☹		
7820255	PFR100R05-SH	2,6	10	8,5	0,5	3,3	XP3310	3	☹		☹		☹	☹			☹	☹		
7820256	PFR100R10-SH	2,6	10	8,5	1	3,3	XP3310	3	☹		☹		☹	☹			☹	☹		
7820257	PFR100R20-SH	2,6	10	8,5	2	3,3	XP3310	3	☹		☹		☹	☹			☹	☹		
7820406	PFR110R03-SH	2,6	11	8,5	0,3	3,3	XP3310	3	☹		☹		☹	☹			☹	☹		
7820407	PFR110R05-SH	2,6	11	8,5	0,5	3,3	XP3310	3	☹		☹		☹	☹			☹	☹		
7820408	PFR110R10-SH	2,6	11	8,5	1	3,3	XP3310	3	☹		☹		☹	☹			☹	☹		
7820409	PFR110R20-SH	2,6	11	8,5	2	3,3	XP3310	3	☹		☹		☹	☹			☹	☹		
7820258	PFR120R03-SH	3	12	10	0,3	4	XP3310	4	☹		☹		☹	☹			☹	☹		
7820259	PFR120R05-SH	3	12	10	0,5	4	XP3310	4	☹		☹		☹	☹			☹	☹		
7820260	PFR120R10-SH	3	12	10	1	4	XP3310	4	☹		☹		☹	☹			☹	☹		
7820261	PFR120R20-SH	3	12	10	2	4	XP3310	4	☹		☹		☹	☹			☹	☹		
7820262	PFR120R30-SH	3	12	10	3	4	XP3310	4	☹		☹		☹	☹			☹	☹		
7820410	PFR130R03-SH	3	13	10	0,3	4	XP3310	4	☹		☹		☹	☹			☹	☹		
7820411	PFR130R05-SH	3	13	10	0,5	4	XP3310	4	☹		☹		☹	☹			☹	☹		
7820412	PFR130R10-SH	3	13	10	1	4	XP3310	4	☹		☹		☹	☹			☹	☹		
7820413	PFR130R20-SH	3	13	10	2	4	XP3310	4	☹		☹		☹	☹			☹	☹		
7820263	PFR160R03-SH	4	16	12	0,3	5,3	XP3310	5	☹		☹		☹	☹			☹	☹		
7820264	PFR160R05-SH	4	16	12	0,5	5,3	XP3310	5	☹		☹		☹	☹			☹	☹		
7820265	PFR160R10-SH	4	16	12	1	5,3	XP3310	5	☹		☹		☹	☹			☹	☹		
7820266	PFR160R20-SH	4	16	12	2	5,3	XP3310	5	☹		☹		☹	☹			☹	☹		
7820267	PFR160R30-SH	4	16	12	3	5,3	XP3310	5	☹		☹		☹	☹			☹	☹		
7820414	PFR170R03-SH	4	17	12	0,3	5,3	XP3310	5	☹		☹		☹	☹			☹	☹		
7820415	PFR170R05-SH	4	17	12	0,5	5,3	XP3310	5	☹		☹		☹	☹			☹	☹		
7820416	PFR170R10-SH	4	17	12	1	5,3	XP3310	5	☹		☹		☹	☹			☹	☹		
7820417	PFR170R20-SH	4	17	12	2	5,3	XP3310	5	☹		☹		☹	☹			☹	☹		
7820268	PFR200R03-SH	5	20	15	0,3	6,7	XP3310	6	☹		☹		☹	☹			☹	☹		
7820269	PFR200R05-SH	5	20	15	0,5	6,7	XP3310	6	☹		☹		☹	☹			☹	☹		
7820270	PFR200R10-SH	5	20	15	1	6,7	XP3310	6	☹		☹		☹	☹			☹	☹		
7820271	PFR200R20-SH	5	20	15	2	6,7	XP3310	6	☹		☹		☹	☹			☹	☹		
7820272	PFR200R30-SH	5	20	15	3	6,7	XP3310	6	☹		☹		☹	☹			☹	☹		
7820418	PFR210R03-SH	5	21	15	0,3	6,7	XP3310	6	☹		☹		☹	☹			☹	☹		

Milling | Indexables



Inserts

PFR INSERTS

Milling | Indexables

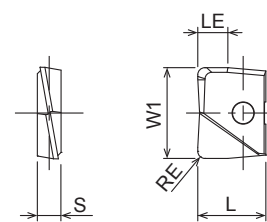
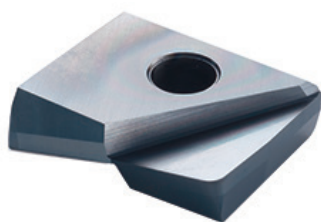

- Finishing corner radius cutter
- Excellent sharpness
- 6 - 32 mm

EDP	Designation	S	W1	L	RE	LE	Grade	Body size	P		M		K		N		S		H		
									dry	⊕	dry	⊕	GG	GGG	dry	⊕	dry	⊕	dry	⊕	
7820419	PFR210R05-SH	5	21	15	0,5	6,7	XP3310	6	⊕		⊕		●	●						●	
7820420	PFR210R10-SH	5	21	15	1	6,7	XP3310	6	⊕		⊕		●	●						●	
7820421	PFR210R20-SH	5	21	15	2	6,7	XP3310	6	⊕		⊕		●	●						●	
7820273	PFR250R03-SH	6	25	18,5	0,3	8,3	XP3310	7	⊕		⊕		●	●						●	
7820274	PFR250R05-SH	6	25	18,5	0,5	8,3	XP3310	7	⊕		⊕		●	●						●	
7820275	PFR250R10-SH	6	25	18,5	1	8,3	XP3310	7	⊕		⊕		●	●						●	
7820276	PFR250R20-SH	6	25	18,5	2	8,3	XP3310	7	⊕		⊕		●	●						●	
7820277	PFR250R30-SH	6	25	18,5	3	8,3	XP3310	7	⊕		⊕		●	●						●	
7820422	PFR260R03-SH	6	26	18,5	0,3	8,3	XP3310	7	⊕		⊕		●	●						●	
7820423	PFR260R05-SH	6	26	18,5	0,5	8,3	XP3310	7	⊕		⊕		●	●						●	
7820424	PFR260R10-SH	6	26	18,5	1	8,3	XP3310	7	⊕		⊕		●	●						●	
7820425	PFR260R20-SH	6	26	18,5	2	8,3	XP3310	7	⊕		⊕		●	●						●	
7820278	PFR300R03-SH	7	30	22,5	0,3	10	XP3310	8	⊕		⊕		●	●						●	
7820279	PFR300R05-SH	7	30	22,5	0,5	10	XP3310	8	⊕		⊕		●	●						●	
7820280	PFR300R10-SH	7	30	22,5	1	10	XP3310	8	⊕		⊕		●	●						●	
7820281	PFR300R20-SH	7	30	22,5	2	10	XP3310	8	⊕		⊕		●	●						●	
7820282	PFR300R30-SH	7	30	22,5	3	10	XP3310	8	⊕		⊕		●	●						●	
7820283	PFR320R03-SH	7	32	23,5	0,3	10,3	XP3310	9	⊕		⊕		●	●						●	
7820284	PFR320R05-SH	7	32	23,5	0,5	10,3	XP3310	9	⊕		⊕		●	●						●	
7820285	PFR320R10-SH	7	32	23,5	1	10,3	XP3310	9	⊕		⊕		●	●						●	
7820286	PFR320R20-SH	7	32	23,5	2	10,3	XP3310	9	⊕		⊕		●	●						●	
7820287	PFR320R30-SH	7	32	23,5	3	10,3	XP3310	9	⊕		⊕		●	●						●	
7820450	PFR060R03-D	2	6	5	0,3	2	XC4505	1							●						
7820451	PFR060R05-D	2	6	5	0,5	2	XC4505	1							●						
7820452	PFR060R10-D	2	6	5	1	2	XC4505	1							●						
7820300	PFR080R03-D	2,4	8	7	0,3	2,7	XC4505	2							●						
7820301	PFR080R05-D	2,4	8	7	0,5	2,7	XC4505	2							●						
7820302	PFR080R10-D	2,4	8	7	1	2,7	XC4505	2							●						
7820303	PFR100R03-D	2,6	10	8,5	0,3	3,3	XC4505	3							●						
7820304	PFR100R05-D	2,6	10	8,5	0,5	3,3	XC4505	3							●						
7820305	PFR100R10-D	2,6	10	8,5	1	3,3	XC4505	3							●						
7820306	PFR120R03-D	3	12	10	0,3	4	XC4505	4							●						
7820307	PFR120R05-D	3	12	10	0,5	4	XC4505	4							●						
7820308	PFR120R10-D	3	12	10	1	4	XC4505	4							●						
7820309	PFR160R03-D	4	16	12	0,3	5,3	XC4505	5							●						
7820310	PFR160R05-D	4	16	12	0,5	5,3	XC4505	5							●						
7820311	PFR160R10-D	4	16	12	1	5,3	XC4505	5							●						
7820312	PFR200R03-D	5	20	15	0,3	6,7	XC4505	6							●						
7820313	PFR200R05-D	5	20	15	0,5	6,7	XC4505	6							●						
7820314	PFR200R10-D	5	20	15	1	6,7	XC4505	6							●						

Milling | Indexables

Inserts

CUTTING CONDITIONS

Milling | Indexables | Cutting conditions

PFR-ST, PFR-SH

Standard conditions

	Work Material	Tensile Strength / Hardness	Cutting Speed Vc (m/min)			Depth of Cut ap (mm)	Feed per Tooth fz (mm/t)			
			L/D				D			
			2,5D	5D	8D		Ø 6,7	Ø 8~11	Ø 12~17	Ø 20~32
P	Mild Steel-Carbon Steel SS400 - S10C	~180HB	200 (150~250)	80%	60%	0,05Dc	0,12	0,2	0,22	0,25
	Carbon Steel-Alloy Steel S50C - SCM440	~280HB	180 (150~250)	80%	60%	0,05Dc	0,15	0,18	0,22	0,25
	Die Steel SKD11 - SKD61	~280HB	150 (120~200)	80%	60%	0,05Dc	0,1	0,15	0,18	0,2
M	Stainless Steel (SUS304 - SUS420)	~250HB	150 (100~200)	80%	60%	0,03Dc	0,08	0,12	0,15	0,18
K	Cast Iron FC250	~300N/mm ²	200 (150~250)	80%	60%	0,05Dc	0,15	0,2	0,25	0,3
	Ductile Cast Iron FCD400	~600N/mm ²	150 (100~200)	80%	60%	0,05Dc	0,12	0,15	0,2	0,25
N	Aluminium Alloy	~13%Si	300 (200~400)	80%	60%	0,05Dc	0,2	0,25	0,3	0,35
S	Superalloy (Wet) (Inconel 718)	-	30 (20~40)	80%	60%	0,02Dc	0,04	0,05	0,08	0,12
	Titanium Alloy (Wet) (Ti-Al-4V)	-	50 (40~60)	80%	60%	0,02Dc	0,05	0,08	0,1	0,15
H	Pre-hardened Steel (NAK80, STAVAX)	40 ~ 43HRC	120 (100~150)	80%	60%	0,03Dc	0,08	0,1	0,12	0,18
	Die Cast Steel (DAC55, DH31)	43 ~ 48HRC	80 (50~100)	80%	60%	0,025Dc	0,05	0,08	0,1	0,15
	Hardened Steel (SKD11)	50 ~ 60HRC	60 (40~80)	80%	60%	0,02Dc	0,04	0,05	0,08	0,1

PFR-D

Standard conditions

	Work Material	Cutting Speed Vc (m/min)			Depth of Cut ap (mm)	Feed per Tooth fz (mm/t)			
		L/D				D			
		2,5D	5D	8D		Ø 6,7	Ø 8~11	Ø 12~17	Ø 20~32
N	Graphite	250 (150~350)	80%	60%	0,1Dc	0,25	0,4	0,5	0,5
	CFRP Carbon Fiber Reinforced Plastic	200 (150~250)	80%	60%	0,5Dc	0,05	0,1	0,15	0,2



CUTTING CONDITIONS

Milling | Indexables | Cutting conditions

PFR - High speed finishing conditions

Steel shank

	Work Material	Tensile Strength / Hardness	Milling Speed Vc (m/min)	Depth of Cut ap (mm)	Feed per Tooth fz (mm/t)			
					D			
					Ø 6~8	Ø 10~13	Ø 16~21	Ø 25~32
P	Mild Steel-Carbon Steel SS400 - S10C	~180HB	450	0,02Dc	0,1	0,12	0,14	0,18
	Carbon Steel-Alloy Steel S50C - SCM440	~280HB	450	0,02Dc	0,07	0,1	0,12	0,14
	Die Steel SKD11 - SKD61	~280HB	375	0,02Dc	0,07	0,1	0,12	0,14
M	Stainless Steel (SUS304 - SUS420)	~250HB	375	0,02Dc	0,07	0,12	0,14	0,17
K	Cast Iron FC250	~300N/mm ²	600	0,02Dc	0,12	0,14	0,18	0,22
	Ductile Cast Iron FCD400	~600N/mm ²	450	0,02Dc	0,1	0,12	0,14	0,18
N	Aluminium Alloy	~13%Si	750	0,03Dc	0,12	0,14	0,18	0,22
S	Superalloy (Wet) (Inconel 718)	-	70	0,015Dc	0,04	0,05	0,06	0,06
	Titanium Alloy (Wet) (Ti-Al-4V)	-	120	0,02Dc	0,06	0,08	0,11	0,13
H	Pre-hardened Steel (NAK80, STAVAX)	40 ~ 43HRC	300	0,015Dc	0,06	0,07	0,08	0,1
	Die Cast Steel (DAC55, DH31)	43 ~ 48HRC	270	0,015Dc	0,05	0,06	0,07	0,07
	Hardened Steel (SKD11)	50 ~ 60HRC	220	0,01Dc	0,05	0,06	0,07	0,07

PFR - High speed finishing conditions

Carbide shank short type

	Work Material	Tensile Strength / Hardness	Milling Speed Vc (m/min)	Depth of Cut ap (mm)	Feed per Tooth fz (mm/t)			
					D			
					Ø 6~8	Ø 10~13	Ø 16~21	Ø 25~32
P	Mild Steel-Carbon Steel SS400 - S10C	~180HB	540	0,02Dc	0,1	0,12	0,14	0,18
	Carbon Steel-Alloy Steel S50C - SCM440	~280HB	540	0,02Dc	0,07	0,1	0,12	0,14
	Die Steel SKD11 - SKD61	~280HB	450	0,02Dc	0,07	0,1	0,12	0,14
M	Stainless Steel (SUS304 - SUS420)	~250HB	450	0,02Dc	0,07	0,12	0,14	0,17
K	Cast Iron FC250	~300N/mm ²	720	0,02Dc	0,12	0,14	0,18	0,22
	Ductile Cast Iron FCD400	~600N/mm ²	540	0,02Dc	0,1	0,12	0,14	0,18
N	Aluminium Alloy	~13%Si	600	0,03Dc	0,12	0,14	0,18	0,22
S	Superalloy (Wet) (Inconel 718)	-	80	0,015Dc	0,04	0,05	0,06	0,06
	Titanium Alloy (Wet) (Ti-Al-4V)	-	150	0,02Dc	0,06	0,08	0,11	0,13
H	Pre-hardened Steel (NAK80, STAVAX)	40 ~ 43HRC	340	0,015Dc	0,06	0,07	0,08	0,1
	Die Cast Steel (DAC55, DH31)	43 ~ 48HRC	290	0,015Dc	0,05	0,06	0,07	0,07
	Hardened Steel (SKD11)	50 ~ 60HRC	260	0,01Dc	0,05	0,06	0,07	0,07

Milling | Indexables



Cutting conditions

CUTTING CONDITIONS

Milling | Indexables | Cutting conditions

PFR - High speed finishing conditions

Carbide shank long type

	Work Material	Tensile Strength / Hardness	Milling Speed Vc (m/min)	Depth of Cut ap (mm)	Feed per Tooth fz (mm/t)			
					D			
					Ø 6~8	Ø 10~13	Ø 16~21	Ø 25~32
P	Mild Steel-Carbon Steel SS400 - S10C	~180HB	480	0,02Dc	0,1	0,12	0,14	0,18
	Carbon Steel-Alloy Steel S50C - SCM440	~280HB	480	0,02Dc	0,07	0,1	0,12	0,14
	Die Steel SKD11 - SKD61	~280HB	400	0,02Dc	0,07	0,1	0,12	0,14
M	Stainless Steel (SUS304 - SUS420)	~250HB	400	0,02Dc	0,07	0,12	0,14	0,17
K	Cast Iron FC250	~300N/mm ²	640	0,02Dc	0,12	0,14	0,18	0,22
	Ductile Cast Iron FCD400	~600N/mm ²	480	0,02Dc	0,1	0,12	0,14	0,18
N	Aluminium Alloy	~13%Si	800	0,03Dc	0,12	0,14	0,18	0,22
S	Superalloy (Wet) (Inconel 718)	-	80	0,015Dc	0,04	0,05	0,06	0,06
	Titanium Alloy (Wet) (Ti-Al-4V)	-	144	0,02Dc	0,06	0,08	0,11	0,13
H	Pre-hardened Steel (NAK80, STAVAX)	40 ~ 43HRC	320	0,015Dc	0,06	0,07	0,08	0,1
	Die Cast Steel (DAC55, DH31)	43 ~ 48HRC	288	0,015Dc	0,05	0,06	0,07	0,07
	Hardened Steel (SKD11)	50 ~ 60HRC	240	0,01Dc	0,05	0,06	0,07	0,07

PFR - High speed finishing conditions

Carbide shank extra long type

	Work Material	Tensile Strength / Hardness	Milling Speed Vc (m/min)	Depth of Cut ap (mm)	Feed per Tooth fz (mm/t)			
					D			
					Ø 6~8	Ø 10~13	Ø 16~21	Ø 25~32
P	Mild Steel-Carbon Steel SS400 - S10C	~180HB	360	0,02Dc	0,1	0,12	0,14	0,18
	Carbon Steel-Alloy Steel S50C - SCM440	~280HB	360	0,02Dc	0,07	0,1	0,12	0,14
	Die Steel SKD11 - SKD61	~280HB	300	0,02Dc	0,07	0,1	0,12	0,14
M	Stainless Steel (SUS304 - SUS420)	~250HB	300	0,02Dc	0,07	0,12	0,14	0,17
K	Cast Iron FC250	~300N/mm ²	480	0,02Dc	0,12	0,14	0,18	0,22
	Ductile Cast Iron FCD400	~600N/mm ²	360	0,02Dc	0,1	0,12	0,14	0,18
N	Aluminium Alloy	~13%Si	600	0,03Dc	0,12	0,14	0,18	0,22
S	Superalloy (Wet) (Inconel 718)	-	60	0,015Dc	0,04	0,05	0,06	0,06
	Titanium Alloy (Wet) (Ti-Al-4V)	-	110	0,02Dc	0,06	0,08	0,11	0,13
H	Pre-hardened Steel (NAK80, STAVAX)	40 ~ 43HRC	240	0,015Dc	0,06	0,07	0,08	0,1
	Die Cast Steel (DAC55, DH31)	43 ~ 48HRC	220	0,015Dc	0,05	0,06	0,07	0,07
	Hardened Steel (SKD11)	50 ~ 60HRC	180	0,01Dc	0,05	0,06	0,07	0,07





shaping your dreams

OSG EUROPE LOGISTICS

Avenue Lavoisier 1
B-1300 Z.I. Wavre - Nord - Belgium
Tel: +32 10 23 05 07
info@osgeurope.com

OSG POLAND Sp. z o.o.

Spółdzielcza 57
05-074 Halinów - Poland
Tel: +22 760 82 71
osg@osg-poland.com

OSG ROMANIA SRL

25C, Bucuresti-Magurele Street (Sector 5)
051431 Bucuresti - România
Tel: +40 21 322 07 47
info@osgromania.ro

OSG BELUX

Avenue Lavoisier 1
B-1300 Z.I. Wavre - Nord - Belgium
Tel: +32 10 23 05 11
info@osg-belgium.com

OSG GERMANY

Karl-Ehmann-Str. 25
D - 73037 Göppingen - Germany
Tel: +49 7161 6064 - 0
Fax: +49 7161 6064 - 444
info@osg-germany.de

AUSTRIA

Branch office of OSG GERMANY
Messestraße 11
A-6850 Dornbirn
Tel: +49 7161 6064-0
info@osg-germany.de

OSG FRANCE

Parc Icade, Paris Nord 2
Immeuble "Le Rimbaud"
22 Avenue des Nations
CS66191 - 93420 Villepinte - France
Tel: +33 1 49 90 10 10
sales@osg-france.com

OSG SCANDINAVIA

(For Scandinavian countries)
Langebjergvaenget 16
4000 Roskilde - Denmark
Tel: +45 46 75 65 55
osg@osg-scandinavia.com

OSG ITALIA

Via Ferrero, 65 A/B3
I - 10098 Rivoli - Italy
Tel: +39 0117705211
info@osg-italia.it

OSG NETHERLANDS

Bedrijfsweg 5 - 3481 MG Harmelen
Tel: +31 348 44 2764
info@osg-nl.com

SWEDEN

Branch office of OSG SCANDINAVIA
Singelgatan 7
212 28 Malmö - Sweden
Tel: +46 40 41 22 55
osg@osg-scandinavia.com

Vischer & Bolli AG

Machining and Workholding
Im Schossacher 17
CH-8600 Dübendorf
T +41 44 802 15 15
info@vb-tools.com

OSG UK

Kelsey Close, Attleborough Fields Ind Est,
CV11 6RS, Nuneaton, United Kingdom.
Tel: +44 1827 720 013
uk_sales@osg-uk.com

OSG IBERICA

Bekolarra 4
E - 01010 Vitoria-Gasteiz - Spain
Tel: +34 945 242 400
osg.iberica@osg-ib.com

CZECH, SLOVAKIA, HUNGARY

OSG Europe Logistics S.A.
Slovakia organizacna zlozka
Racianská 22/A, SK-83102 Bratislava
Slovakia
Tel. +421 24 32 91 295
Orders-osgsvk@osgeurope.com

OSG TURKEY

Rami Kışla Cad.No:56 Eyüp
Istanbul 34056 - Turkey
Tel+90 212 565 24 00
Fax: +90 212 565 44 00
info@osg-turkey.com

OSG EUROPE LOGISTICS S.A.

01/2023 - All rights reserved. © OSG Europe 2023.

The contents of this catalogue are provided to you for viewing only. They are not intended for reproduction either in part or in whole in this or other medium. They cannot be copied, used to create derivation work or used for any reason, by means without the express, written permission of the copyright owner. If prices are stated, they are netto unit-prices and any eventual tax(es) have to be added. The company is not responsible for any printing error in technical, price and/or any other data.

Tool specifications subject to change without notice.

www.osgeurope.com

